

# Wireless World

ELECTRONICS, RADIO, TELEVISION

MARCH 1963

*Editor:*

F. L. DEVEREUX, B.Sc.

*Assistant Editor:*

H. W. BARNARD

*Editorial:*

P. R. DARRINGTON

D. R. WILLIAMS

*Drawing Office:*

H. J. COOKE

*Production:*

D. R. BRAY

*Advertisement Manager:*

G. BENTON ROWELL

- 105 Editorial Comment
- 106 Transistor Bias Networks *By T. Ormond*
- 109 Direct-coupled Pulse Circuits *By R. Thompson*
- 111 Books Received
- 112 Paris Components Show
- 114 Citizens' Radio in U.S.A. *By R. L. Conhaim*
- 115 H. F. Predictions—March
- 116 World of Wireless
- 118 Personalities
- 120 News from Industry
- 121 *Wireless World* Oscilloscope—1
- 128 Aerospace Telemetry
- 129 Physical Society Exhibition 1963
- 134 Letters to the Editor
- 137 Oscillators: a Monastic Approach—3 *By T. Roddam*
- 142 Manufacturers' Products
- 145 Nonconductor Valves *By "Cathode Ray"*
- 148 Transistor Amplifier Output Stages—3 *By O. Greiter*
- 152 Unbiased *By "Free Grid"*
- 154 March Meetings

VOLUME 69 No. 3

PRICE: 2s 6d.

FIFTY-SECOND YEAR

OF PUBLICATION

*Managing Director:* W. E. Miller, M.A., M.Brit.I.R.E.

Iliffe Electrical Publications Ltd., Dorset House, Stamford Street, London, S.E.1

*Please address to Editor, Advertisement Manager or Publisher as appropriate*

© Iliffe Electrical Publications Ltd., 1963. Permission in writing from the Editor must first be obtained before letterpress or illustrations are reproduced from this journal. Brief abstracts or comments are allowed provided acknowledgement to the journal is given.

PUBLISHED MONTHLY (4th Monday of preceding month). Telephone: Waterloo 3333 (70 lines). Telegrams: "Ethaworld, London, Telex." Cables: "Ethaworld, London, S.E.1." Annual Subscriptions: Home and Overseas, £2 0s. 0d. Canada and U.S.A. \$5.50. Second-class mail privileges authorized at New York, N.Y. BRANCH OFFICES: BIRMINGHAM: King Edward House, New Street, 2. Telephone: Midland 7191. COVENTRY: 8-10, Corporation Street. Telephone: Coventry 25210. GLASGOW: 62, Buchanan Street, C.1. Telephone: Central 1265-6. MANCHESTER: 260, Deansgate, 3. Telephone: Blackfriars 4412. NEW YORK OFFICE: U.S.A.: 111, Broadway, 6. Telephone: Digby 9-1197.

# CONTROLLED WARM-UP TIMES

## FOR TELEVISION SERIES HEATER CHAINS

All Mullard valves designed for operation in television series heater chains now possess equalised heating characteristics. These characteristics obviate damage to the valve heaters during the warm-up period and eliminate the need for a thermistor.

The voltage developed across one heater of a series heater chain depends almost directly on the resistance of that heater. The resistance of the heaters depends on their temperature, and is greater when the valves are hot than when they are cold. When a receiver is switched on, if one valve warms up more rapidly than the rest, the effect on the current will not be appreciable, but the increase in the voltage developed across the heater of that valve can exceed the amount (50% above the nominal heater voltage) which can be tolerated during the warm-up period. This can shorten the life of the valve considerably, and to prevent it, heater chains have normally been designed to incorporate a thermistor.

The resistance of a thermistor is high when it is cold, but falls as heat is generated in it by the heater current. The thermistor thus reduces the rate of increase of the heater current, and prevents unequal rises in the temperature of the heaters from producing an excessive voltage across any heater.

The rate at which the temperature of a valve heater rises depends very much on the mounting of the heater in the valve. Any point of contact between the insulated heater and the surrounding cathode sets up a small drainage of heat away from the heater and thus retards the rate at

which the temperature rises. Since the space inside the cathode is small, it is difficult to ensure consistent positioning of the heater within the cathode, so that the number and extent of these contacts, and therefore the rate at which the heater temperature rises, can vary considerably from one valve to another. Now, however, Mullard have developed accurate and carefully controlled methods of manufacture which produce equalised rates of temperature rise in all their television valves. Extensive tests with a large number of valves in typical heater chains have shown that these equalised heating properties ensure that, without added protection, the voltage developed across any heater will not exceed the permitted 50% above nominal during the warm-up period. Use of Mullard television valves thus enables heater chains to be designed without a thermistor, and this, in addition to the obvious economy, leads to shorter warm-up times and a faster appearance of the picture on the screen.

### WHAT'S NEW IN THE NEW SETS

These articles describe the latest Mullard developments for entertainment equipment

## MULLARD MINIATURE ELECTROLYTICS

### 8 Values in the New Can Size 2½

Mullard miniature electrolytic capacitors of the C426 series are a proven success in modern transistor radio receivers, and the group of capacitors recently added to the series offers even better coverage of the already wide range of sizes and values available. The capacitance and working voltage values of electrolytic capacitors are linked closely with the size of the component. The original

Mullard C426 series consisted of five can sizes, each of which offered eight combinations of capacitance and working voltage. A new can size—can size "2½"—has now been added to the series, so that a further eight combinations of capacitance and voltage are now available. As the designation implies, can size 2½ lies between can sizes 2 and 3. It has the same length of 10.7 mm., as can size 2

## NEW MINIATURE TRANSISTORS FOR POCKET PORTABLES

A new Mullard range of miniature transistors has recently been introduced for pocket-size portable radios. These very small transistors—the AF124, AF125, AF126 and AF127—have been evolved as a continuation of the Mullard contribution to miniaturisation which began with the well-known OC44 and OC45 alloy-junction transistors.

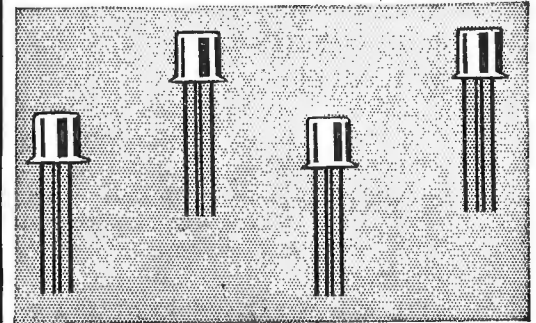

Early transistor sets were restricted to the long and medium wavebands but short-wave and v.h.f. operation became feasible with the improved frequency performance of transistors manufactured by the alloy-diffusion technique. The first of these r.f. transistors to be introduced by Mullard were the OC170 and OC171, but these were superseded by the now-established AF114, AF115, AF116, and AF117—a series that was soon accepted as fulfilling the h.f. requirements of all forms of portable receiver.

The new series is a miniature counterpart of the AF114 series: the electrical properties are identical, but the transistors are only a quarter of the size. All the many advantages of the alloy-diffusion technique are retained, but considerable economy of space is afforded. These benefits are reflected in the smaller size and improved performance of the latest pocket portables.

compared with the 18.7 mm. of size 3. Its diameter of 6.3 mm. compares with the 5.0 mm. of size 2 and the 6.8 mm. of size 3. As with the other sizes in the C426 range, the eight working voltages follow the logarithmic series: 64, 40, 25, 16, 10, 6.4, 4.0 and 2.5V, and the corresponding values of capacitance are 3.2, 6.4, 12.5, 20, 32, 40, 50 and 64μF. The tolerance on these values is -10% and +50%. The electrical properties of the new capacitors are identical with those of the original capacitors, and in common with the whole range, the capacitors in can size 2½ offer a long and trouble-free service life.

MVE/CA103I

## Making and Doing

THIS journal is a meeting place for all interests in the world of radio and electronics. We cover a wide field not only of subject matter but of motives for interest in these subjects. A recent survey showed that 60% of our readers were gainfully employed in the electronics industry, while the remaining 40% were following their natural interest solely as a hobby. There is no hard line of demarcation between these categories and many of our readers have specialist interests in one branch of the subject as professionals and in others as amateurs. No reader is ever likely to be satisfied with the proportion of each issue devoted to his subject(s), but if we cannot supply the quantity we can at least attend to the quality. We are helped in this by pressure on space, which forces us to be selective. At the same time we try to preserve a proper balance between conflicting demands and to adjust our contents to changing needs.

We are grateful to those readers who from time to time write with criticisms and suggestions, and it is clear from their letters that more constructional articles would be welcome—not, as in the early days of broadcasting, as a means of building a receiver cheaper than a proprietary make (those days are long past) but for the satisfaction of proving theory by experiment and for the sense of achievement which comes from building a piece of hardware with one's own hands. Complaints that we have neglected the home constructor and become a "high-brow" journal are often made. True, we have followed the growing complexity of our subject, but a check on the contents of last year's volume shows that there was at least one constructional article in 11 of the 12 issues.

Many of our constructional articles have come from outside contributors whose background is known to us and whose competence is not in doubt. Some (e.g., Williamson) have achieved world-wide fame, but it is with the more plentiful supply of good sound wine, rather than the occasional vintage (which will, in any case, take its own time to appear) that we are primarily concerned.

To provide more of the "right-stuff" we must help ourselves, and to this end we have recently overhauled our own laboratory facilities and brought them up to date with a background of

modern professional measuring equipment. We intend to supplement these with a range of sound, but less expensive, measuring instruments which we shall design and make ourselves with the kind of tools which the average enthusiast can afford and knows how to use.

This work will be undertaken as much for our own satisfaction as for our readers' and we look forward to working together on the many interesting projects which we shall think up between us.

In deference to the often expressed wish of a majority of readers interested in construction we shall start with test instruments. The equipment which we are developing will not compete either in cost with the cheapest commercial instruments or in performance with professional laboratory standards, but our designs will be adequate for most needs and will aim to bridge the gap and combine some of the advantages of both these extremes. Their greatest value will be in the satisfaction they give in the building and the confidence with which they will be handled when finished. Any faults which may develop at some future date will be much easier to trace and rectify in an instrument one has built oneself.

We are starting with a comparatively ambitious oscilloscope, because we think this is not only fundamental as a measuring instrument, but is most rewarding in the variety of observations which can be made with it. Other equipment—some simpler, some more complex—will follow, and as far as possible transistors will be used. It is also planned to build to a standard modular form, so that eventually the units can be used separately or rack-mounted to form a comprehensive test console.

In embarking on this new series of *Wireless World* Test Instruments we are not breaking with any of the principles which have guided us in the past. On the contrary, we are making a slight shift of emphasis to restore the balance of the whole so that we can continue to serve all who have an interest in radio and electronics at any level. We think that the young man who has built his own instruments as an amateur will have better judgement as a professional when it comes to selecting the right kind of equipment for advanced research and development.

# Transistor Bias Networks

SIMPLE DESIGN PROCEDURE

By T. ORMOND\*

**T**HIS paper is written for the technician or hobbyist in an attempt to fill the void of transistor bias network design. The theory of bias networks can be found in numerous textbooks and has been the subject of many magazine articles. A most serious drawback to the existing literature (as far as the technician or hobbyist is concerned) is that the articles are usually oversimplified with poorly-explained assumptions, while the textbook material is too involved in mathematics and theoretical derivations to be of practical value to the hobbyist or technician.

Because of the wide variety of transistor circuitry, it will be necessary to restrict our discussion somewhat. We will discuss the biasing of a Class A amplifier. Because of its popularity and wide-spread usage, we will use the common-emitter connection in our design example.

Two of the most important criteria for a well-designed bias network are the resultant stability factor and the degree to which the amplifier can be made insensitive to transistor replacement. (The stability factor is a measure of an amplifier's ability to maintain a given set of bias conditions over a range of operating temperatures.) The transistor is a temperature sensitive device, particularly with respect to the collector cut-off current  $I_{c0}$  ( $I_{cbo}$ ) and the input voltage  $V_{be}$ . The collector cut-off current will approximately double for every 10°C rise.

In the common-emitter connection, Fig. 1, the collector current is given by the equation:

$$I_c = \beta I_b + S I_{c0} \dots \dots \dots (1)$$

where  $\beta$  is the common-emitter current gain and  $S$  is the stability factor (for good stability,  $S$  should be low—the ideal being  $S = 1$ ). If the stability factor is high and any great degree of temperature variation is experienced, the change in  $I_c$  could be large enough to cause the circuit to become inoperative. There is nothing we can do about the leakage current of any given transistor, this current being inherent in the device, but we can make the stability factor such that the circuit can withstand the expected temperature variation. The amplifier shown in Fig. 1 offers a good degree of stability with minimum sacrifice in other circuit parameters. For this circuit and most circuits, the stability factor is:

$$S = \frac{\beta + 1}{1 + \frac{\beta R_e}{R_b + R_e}} \dots \dots \dots (2)$$

where  $R_b = R_1 R_2 / R_1 + R_2$ . Examining equation (2), we can see that poor stability results when  $R_e$  approaches zero ( $S$  approaches  $\beta + 1$ ) and ideal stability results when  $R_b$  approaches zero ( $S$  approaches 1). We will later show that this ideal stability is unrealisable in the circuit of Fig. 1. The degree of stability designed for will depend

upon the application, but a useful "rule of thumb" for highly stabilised circuits is:

$$S \leq 5 \dots \dots \dots (3)$$

Circuits which possess good temperature stability are usually also insensitive to transistor replacement problems. This is especially true of the circuit of Fig. 1. Obtaining the base bias voltage by means of a resistive divider essentially makes the circuit independent of transistor parameters. For the circuit of Fig. 1, the base bias voltage  $V_b$  is given by:

$$V_b = \frac{V_{cc} R_x}{R_1 + R_x} \dots \dots \dots (4)$$

$$\text{where } R_x = \frac{R_2 (\beta + 1) R_e}{R_2 + (\beta + 1) R_e}$$

As shown in equation (2), good temperature stability requires that the ratio  $R_b/R_e$  be small. Thus, in most cases,  $\beta R_e$  will be many times larger than  $R_2$  and  $R_x$  nearly equals  $R_2$ . Equation (4) then becomes

$$V_b \approx \frac{V_{cc} R_2}{R_1 + R_2} \dots \dots \dots (5)$$

Equation (5) gives  $V_b$  in terms completely independent of the transistor. We can also assume that  $V_b$  equals  $V_e$  ( $V_b$  will be greater than  $V_e$  by the magnitude of the voltage drop across the forward biased base-emitter diode, a matter of tenths of a volt). Since the value of  $V_e$  is independent of the transistor,  $I_e$  will also be independent ( $I_e = V_e/R_e$ ), greatly reducing any change in  $I_c$  due to transistor replacement. Assumptions usually make the actual case worse than the ideal, so our operating point will not remain as stable as the foregoing discussion would indicate. However, operating-point shifts due to transistor replacement will be greatly alleviated in a circuit of the type shown in Fig. 1. The problems concerned with stability can be

reduced by a wise choice of the quiescent (d.c.) operating point, a choice which we will now discuss.

Fig. 2 shows the common-emitter output characteristics of an n-p-n transistor. It is a plot of collector to emitter voltage ( $V_{ce}$ ) versus collector current ( $I_c$ ) for various values of base current ( $I_b$ ). Values of  $V_{ce}$  and  $I_c$  should be chosen so that the operating point  $Q$  is in the linear range of the characteristic

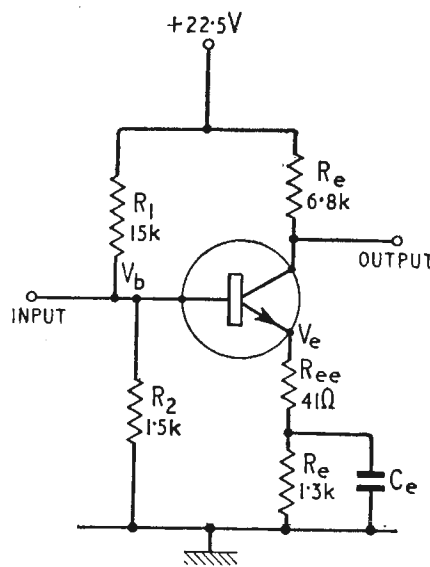

Fig. 1. Stabilisation by potential divider and emitter resistor.

\*Sylvania Semiconductor Division, Woburn/Mass. U.S.A.

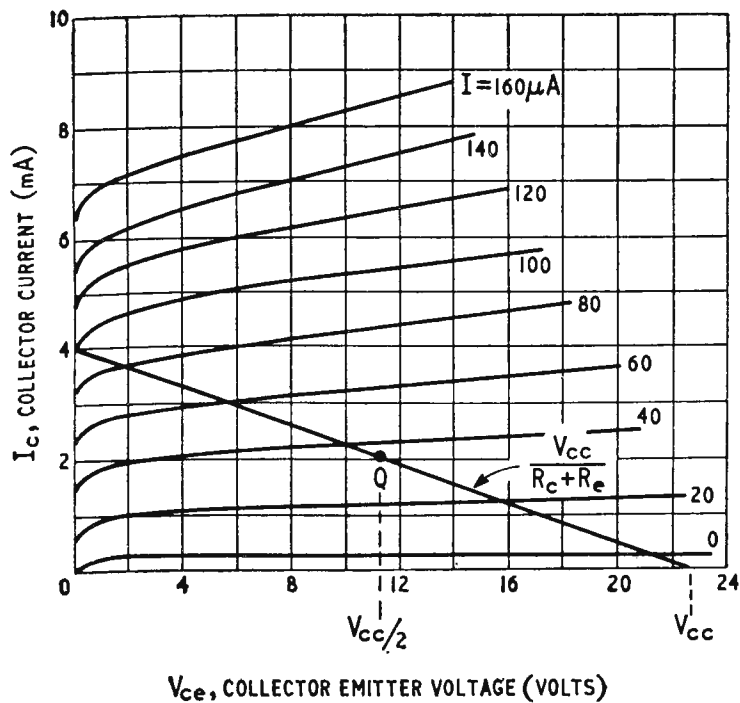

Fig. 2. Output characteristic of common-emitter n-p-n transistor.

curves (the point Q shown on the figure has no meaning other than to demonstrate operating point placement). It can be shown, by means which need not be discussed here, that the optimum condition for temperature stability is when  $V_{ce} = V_{cc}/2$ . In some instances, such as in direct-coupled stages, it is not always possible to meet this criterion, but the relationship  $V_{ce} = V_{cc}/2$  should be met as nearly as possible (standard resistance values may make an exact match impossible). Establishing the operating point is now reduced to determining the value of  $I_c$ . There are several factors to be considered in selecting a value for  $I_c$ ; stage gain and collector dissipation to mention two. The amplifier gain will depend on  $I_c$ , since  $\beta$  is to some extent a function of collector current. Entertainment type transistors are normally used in low-voltage circuits, so appreciable  $\beta$ 's will be found at low collector currents (1-3mA range). A value of  $I_c$  must be chosen to give good  $\beta$  but care must be used to insure that it places the operating point in the linear region of the characteristic curves. The supply voltage must also be considered. Its value will probably be dictated by existing circuitry to which we are adding a stage, or by available standard batteries. Meeting the criterion of  $V_{ce} = V_{cc}/2$  will allow only  $V_{cc}/2$  to be dropped across  $R_c$  and  $R_e$ . Thus, choosing a high value of  $I_c$  to obtain a good  $\beta$  could make  $R_c$  so small as to adversely affect stage gain. It naturally follows that the higher the available supply voltage (short of the value that would make  $V_{ce}$  greater than the breakdown voltage of the transistor), the greater the latitude in the choice of collector current. The collector power dissipation must also be considered when choosing  $I_c$ . The dissipation limit of some transistors may be as low as 25 mW. If we have a  $V_{cc}$  such that  $V_{ce} = 10$  V, then the maximum collector current, from the equation

$$P_c = V_{ce} I_c \quad (6)$$

would be 2.5 mA. It is evident that the choice of  $I_c$  is governed by many factors. In the design procedure outlined in this paper,  $I_c$  is determined from values of  $R_c$  and  $R_e$  which have been calculated from gain and stability considerations. Although this may seem

to be a haphazard way of choosing  $I_c$ , the design procedure will show that this is not the case.

Before proceeding with a design example, we must consider a factor which complicates our stability considerations; namely, the input circuit loss factor. Fig. 3 shows the equivalent a.c. input circuit of our amplifier of Fig. 1.  $r_i$ , the a.c. input resistance of the transistor, is given by the equation:

$$r_i = r_b + (\beta + 1) R_e \approx (\beta + 1) R_e \quad (7)$$

where  $R_e$  is equal to  $r_e + R_{ee}$ .  $R_{ee}$  is equal to any external resistance which is not a.c. by-passed and  $r_e$  is the internal emitter resistance, approximately:

$$r_e = \frac{26}{I_e \text{ (mA)}} \Omega \quad (8)$$

We are interested in getting maximum signal power transfer from the source (i.e., a signal generator or the output of a previous stage). In other words, we want  $v_2 i_b$  to approach  $v_g i_g$  as nearly as possible. The best condition we can obtain is when  $r_i = R_g$  in which case  $v_2 i_b$  will equal  $v_g i_g / 2$  (this represents a 3 dB power loss). This could most easily be accomplished by making  $r_i = R_g$  and then making  $R_b$  large enough ( $R_b > 10 r_i$ ) so that it will have negligible effect on  $r_i$ . This arrangement would pose serious stability problems, however, as well as curtailing the gain possibilities of the amplifier. We have previously noted that for good stability, the ratio  $R_b/R_e$  should be small. Now although it is true that  $r_i$  is an a.c. resistance, and as such will not necessarily include the full value of  $R_e$ , making  $r_i$  equal to  $R_g$  could make  $R_b$  very large when  $R_g$  is large (since  $R_g$  could be the output resistance of a previous stage, it could vary from the low value of a common-collector to the moderately high value of a common-emitter stage). To get good stability with a large value of  $R_b$ , we must make  $R_e$  large which in itself is no problem (since in the majority of cases it will be a.c. by-passed). The problem arises when we consider stage gain, which is approximately:

$$A_v = \frac{R_c}{R_e} \quad (9)$$

where  $R_e$  is as defined in equation (7). If we desire a high gain from our stage, the ratio  $R_c/R_e$  must be large (40 dB would make the ratio equal to 100). Since it is desirable to make  $V_{ce}$  equal to  $1/2 V_{cc}$ , we are faced with the problem of dropping  $1/2 V_{cc}$  across the resistances  $R_c$  and  $R_e$ , both of which will be large ( $R_c$  from gain and  $R_e$  from stability considerations). This would lead to a low value of  $I_c$  which is a condition we do not want. It is evident, therefore, that unless we require a low gain or the source resistance is low, we must accept some loss in our input circuit. The question is, how much loss? Table I shows the degree of loss experienced for various mismatch conditions. Since we cannot avoid a 3 dB loss, we will not consider this loss in

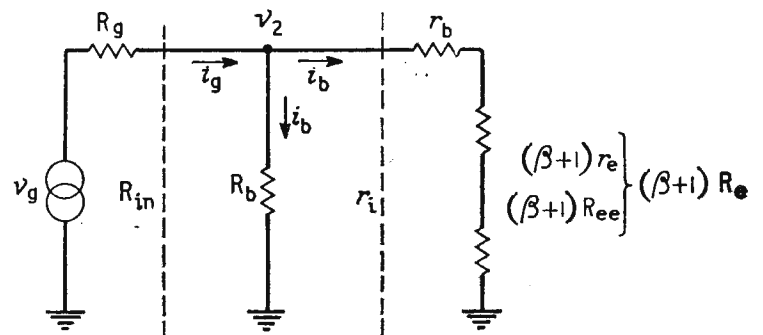

Fig. 3. Equivalent circuit of Fig. 1 amplifier.



our calculations. What we must decide is how much loss, over and above the unavoidable 3 dB, we shall accept in our input circuit. From Table I, we see that if  $R_{in}$  equals  $R_g/7$ , we will have a 6 dB loss in our input circuit (excluding the unavoidable 3 dB). This ratio will allow us to obtain good gain and stability factors without much trouble and it does not represent too severe an input circuit loss. We will, therefore, design around this input condition and define a further loss factor involving  $R_b$  and  $r_i$ :

$$K = \frac{R_b}{R_b + r_i} \dots \dots \dots (10)$$

Since the lower the ratio  $R_b/R_e$  the better, we will assign a design value to  $K$  of 0.5; in other words, we will make  $R_b$  equal to  $r_i$ . Therefore:

$$R_b = r_i = 2R_g/7 \dots \dots \dots (11)$$

will be our starting relationship. The foregoing discussion has been based on the value of  $\beta$  being low which will not always be the case. Any reader in a position to obtain transistors with known high  $\beta$  values will not be faced with the problems just discussed. The following design procedure is based on the premise that  $\beta$  information is not available. A low value of  $\beta$  is assumed which represents a "worst case" condition, a condition which insures that at least the objectives designed for will be obtained. If it is felt that input matching is of prime importance, then a multi-stage amplifier can be designed. A paper design will quickly confirm if a single stage will suffice for matched input or whether the ratio  $R_g/R_{in}$  can be made more stringent (less than 7/1), reducing input losses. The following example shows the simplicity of the calculations.

We will start with the following information: we require an amplifier with 40 dB of voltage gain, the source resistance is 5 k $\Omega$ , and we have a 22.5 volt battery for our power source. We will also take as our "worst case" conditions, a value of  $\beta = 20$  and design for  $S = 2$  ( $\beta = 20$  is not unrealistically low for entertainment-type transistors). We wish to use a single stage without necessarily matching the input. From equation (11), we have:

$$R_b = r_i = \frac{2R_g}{7} = \frac{10K}{7} = 1430 \Omega \dots (12)$$

We can now rewrite equation (2), solving for  $R_e$

$$R_e = \frac{R_b(\beta + 1 - S)}{(S-1)(\beta + 1)} = \frac{1430(19)}{21} = 1300 \Omega (13)$$

With 40 dB of gain required, equation (9) gives

$$R_c = 100 R_e \dots \dots \dots (14)$$

TABLE I

$\frac{R_g}{r_i}$ or $\frac{r_i}{R_g}$	Power Loss (dB)	Power Loss From Optimum (dB)
1	3.0	0
2	4.8	1.8
3	6.0	3.0
4	7.0	4.0
5	7.8	4.8
6	8.5	5.5
7	9.0	6.0
8	9.6	6.6
9	10.0	7.0

TABLE II

$\beta$	S	$A_v$ (dB)	$I_c$ (mA)	$V_{ce}$ (volts)	$P_c$ (mW)	Input Losses (dB)	$V_b$ (volts)
25	1.86	40.3	1.46	10.7	15.9	8.8-5.8	1.97
50	1.96	40.4	1.48	10.5	15.6	7.9-4.9	2.0
100	1.98	40.5	1.50	10.4	15.6	7.4-4.4	2.02

From equation (7)

$$R_e = \frac{r_i}{\beta + 1} = \frac{1430}{21} = 68 \Omega \dots \dots (15)$$

Thus, from equation (14)

$$R_c = 100 R_e = 6.8 \text{ k}\Omega \dots \dots \dots (16)$$

We can now calculate  $I_c$

$$I_c = \frac{V_{cc}/2}{R_c + R_e} = \frac{11.25}{8.1} = 1.4 \text{ mA} \dots (17)$$

As seen from the typical characteristics of Fig. 2, an  $I_c$  of 1.4 mA places our operating point advantageously and also keeps collector dissipation low ( $P_c \approx 16 \text{ mW}$ ). The only calculations remaining are those of the resistances  $R_{ee}$ ,  $R_1$ , and  $R_2$ . From (8),

$$r_e = \frac{26}{1.4} = 19 \Omega \dots \dots \dots (18)$$

$$\text{Since } R_e = r_e + R_{ee} = 68 \Omega \dots \dots \dots (19)$$

$$R_{ee} = 68 - 19 = 47 \Omega \dots \dots \dots (20)$$

Rather than bother to calculate how to divide the value of  $R_e$  from equation (13) to give  $R_{ee}$ , we will simply add the 47 $\Omega$  in series with our calculated value of  $R_e = 1.3 \text{ k}\Omega$  (this procedure will have negligible effect on our emitter calculations). We can write the following equations for the bias network

$$\frac{R_1 R_2}{R_1 + R_2} = R_b = 1.43 \text{ k}\Omega \dots \dots (21)$$

$$\frac{R_2}{R_1 + R_2} = \frac{V_b}{V_{cc}} = \frac{V_e}{V_{cc}} = \frac{I_c R_e}{V_{cc}} = \frac{1.82}{22.5} \dots (22)$$

Equations (21) and (22) are solved to yield  $R_1 = 17.7 \text{ k}\Omega$  and  $R_2 = 1.56 \text{ k}\Omega$ . Fig. 1 shows that we have made  $R_1$  and  $R_2$  equal to the next smallest standard resistance values (a rather obvious choice for  $R_2$ ). By making  $R_1$  smaller, we take into account that  $V_b > V_e$  and not equal to it as we have previously assumed. The completed amplifier is shown in Fig. 1, with standard resistance values for all components. Since  $C_e$  will be determined by factors not covered in this paper (desired frequency response), its value has not been calculated.

Using the principles set forth for good bias network design, we have completed the design for a common-emitter amplifier. Since several assumptions were made during the design, bench testing may indicate minor changes for improving operation. By designing around "worst case" conditions for  $\beta$  and  $S$ , it is felt that design objectives will be met under a wide variety of conditions. Table II shows measured circuit parameters using transistors with  $\beta$ 's of 25, 50 and 100. It is evident that our desire to make amplifier performance insensitive to transistor replacement has been fulfilled. By following the steps for bias network design outlined in this article, any reader should be able to design a transistor amplifier for his specific needs.

# DIRECT-COUPLED PULSE CIRCUITS

GRAPHICAL DESIGN METHOD

By R. THOMPSON,\* Grad. I.E.E., Grad. Brit. I.R.E.

**I**N many pulse circuits it is required to switch a transistor into either its fully conducting or its nonconducting state via a resistive coupling chain. A good example is the bi-stable circuit of the type shown in Fig. 1. The values of  $R_1$  and  $R_2$  must be chosen so that the transistors receive either sufficient base current or sufficient reverse base voltage to maintain the required states under all tolerance conditions. Satisfactory values for the resistors may be found by straightforward calculation, but this involves either surprisingly cumbersome simultaneous equations or tedious repetitive approximations. This is particularly true where the effects of several tolerances are required to be known. A graphical approach to this problem is attractive because the interaction of circuit conditions may be seen at a glance. In effect the construction replaces a series of equations with a series of lines whose implications are more readily appreciated and can be easily altered. The construction described here is extremely simple and consists entirely of straight lines.

The basic construction is shown in Fig. 2; the axes of voltage and resistance allow the circuit currents to be represented by the slope of lines drawn in the construction. Suitable manipulation of these lines will allow the required information to be obtained. For simplicity it is assumed that the bottoming voltage of VT1 and the forward base-emitter voltage of VT2 are both zero. It is required that when VT1 is nonconducting VT2 takes a base current of at least  $I_b$  and when VT1 is bottomed VT2 must be cut off by at least  $V_{BE}$  volts. The leakage current of VT2 is  $I_{co}$ .

## Construction Procedure (refer to Fig. 2)

- (1) Mark off the vertical axis in volts and the horizontal axis in ohms.
- (2) On the vertical axis mark in the three supply levels  $V_1$ ,  $V_2$  and 0. On the horizontal axis mark in  $R_L$ .
- (3) Choose a value of  $R_1$  (see later) and mark in the point  $(R_L + R_1)$ .

Fig. 1. Basic bi-stable switch.

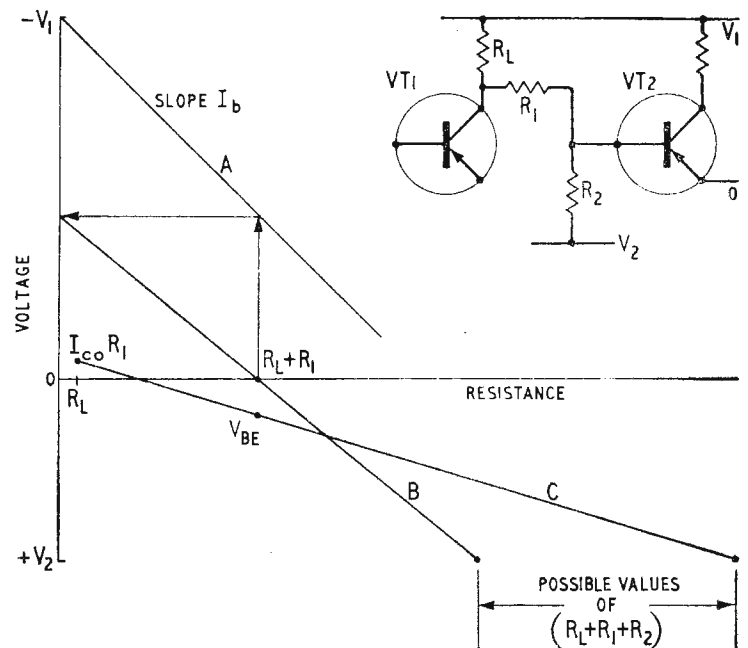
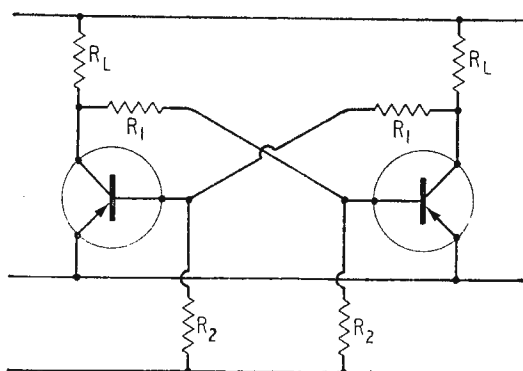

Fig. 2. Construction for  $R_L$ ,  $R_1$  and  $R_2$ .

- (4) From point  $(0, V_1)$  draw a line with slope equal to  $I_b$  (line A).
- (5) Construct back from point  $(R_L + R_1, 0)$  to line A and hence draw in line B through  $(R_L + R_1, 0)$ . This construction subtracts  $I_b$  from the current flowing in  $R_1$ . The slope of the resulting line is the current through  $R_2$  and therefore its intersection with the  $V_2$  level will give the value of  $(R_L + R_1 + R_2)$ . The value of  $R_2$  given by line B is the minimum which will result in sufficient base current in VT2.
- (6) Mark in  $(R_L, 0)$ . Add on a further voltage  $I_{co} \times R_1$ , to allow for the leakage current that flows when VT2 is cut off, giving point  $(R_L, I_{co} R_1)$ . Mark in point  $(R_L + R_1, V_{BE})$ . Draw in line C. Intersection of C with  $V_2$  level gives the maximum value of  $R_2$  which will result in sufficient cut-off bias.

The choice of  $R_1$  (stage (3)) is not as arbitrary as it may at first seem because the range of values which will give a satisfactory solution is limited. While an equation defining this range is cumbersome, and even approximation results in 
$$0 = R_1^2 I_b (V_2 - V_{BE}) + R_1 [V_2 V_{BE} + (I_b R_E - V_1) (V_2 - V_{BE})] + R_L V_2 V_{BE}$$
 two rough limits may be used. The value chosen must not be greater than  $(V_1/I_b - R_1)$  if sufficient base current is to follow (in fact it must always be less than this to obtain a satisfactory cut-off condition). The minimum value of  $R_1$  is restricted by the loading it imposes on VT1 collector. Even if these guides are ignored and an unsatisfactory value of  $R_1$  chosen the

\*The Plessey Company (U.K.) Ltd.

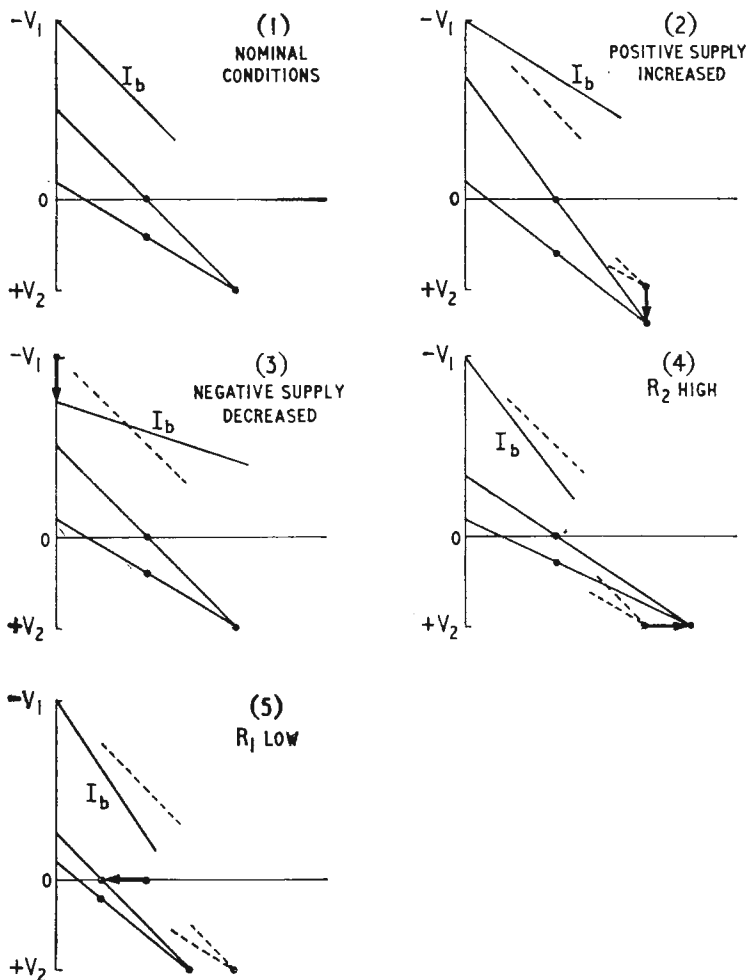

Fig. 3. Modifications to basic construction to take account of variations in supply and resistance values.

simple construction allows alteration in a matter of seconds.

The basic construction described is readily extended to give more precise results and include other design restrictions. The saturation voltage of VT1 (or collector clamping voltage if a non-saturating circuit is used) may be included in stage (6) by using point  $(R_L, V_{sat})$  instead of  $(R_L, 0)$ . The forward base emitter voltage of VT2,  $V_{BE}$ , required for a current of  $I_b$  can be included at stage (5) by replacing the point  $(R_L + R_1, 0)$  with  $(R_L + R_1, V_{BE})$ . Because of the danger of voltage breakdown, or in the case of a bi-stable circuit a limit on triggering sensitivity, some maximum reverse emitter base voltage,  $V_R$ , may be specified and this could restrict the value of  $R_2$ . The worst condition for reverse base voltage occurs with zero  $I_{co}$ ; a line drawn from  $(R_L, 0)$  (or  $(R_L, V_{sat})$ ) through  $(R_L + R_1, V_R)$  to intersect the  $V_2$  level will show the minimum safe value of  $R_2$ .

Once a construction has been made it is very easy to alter conditions either to optimise the design for a particular requirement or to investigate the effect of tolerances. The main points of reference will be marked in already and hence only a few movements of a straight edge are required. Fig. 3 illustrates a simple construction and the manner in which it can be modified to show the effects of supply and component tolerances. The tolerance variations used are exaggerated to make their effects readily apparent. It can be seen that the information required can be obtained in a few seconds. If the only information required is the values of  $R_1$  and  $R_2$  for satisfactory operation under "worst case" conditions then a simple construction using appropriate tolerance values will be sufficient.

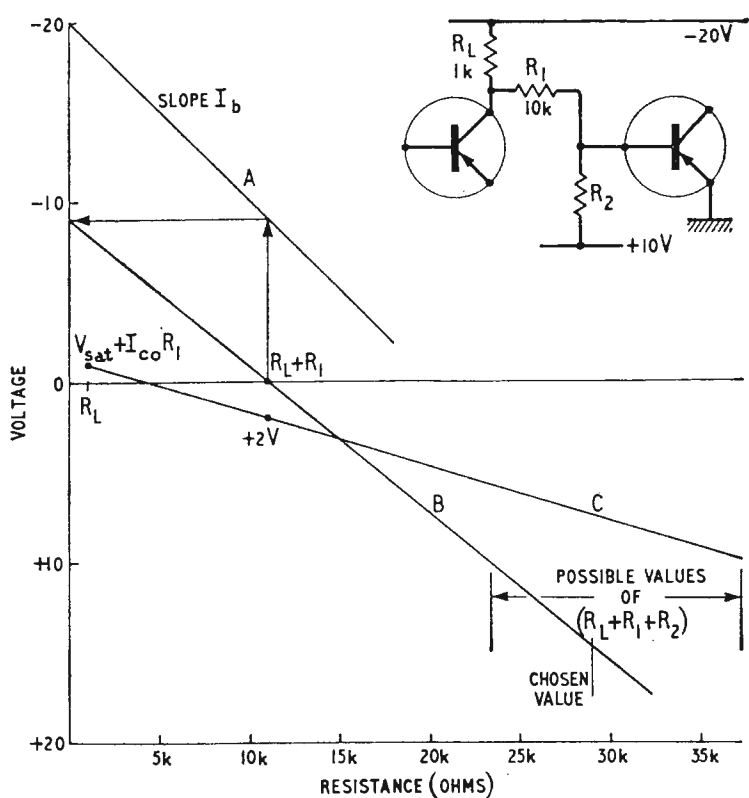

Fig. 4. Practical example of design method.

In a bi-stable circuit the approximate condition for sufficient loop gain is  $R_1 < \beta R_L$ . Provided the transistors are designed to saturate, this condition is satisfied since  $R_1$  must be less than  $V_1/I_b$  or  $V_1/(V_1/R_L\beta)$ , i.e. less than  $R_L\beta$ , assuming  $R_L \ll R_1$ .

**Practical Example.**—As an example of this constructional design method consider the following problem. Required, a bi-stable circuit to operate with the following conditions.

- $V_1 = -20V, V_2 = +10V, R_L = 1k\Omega.$
- $V_{sat} = -0.5V, I_{co\ max} = 50\ \mu A, V_{BE} = +2V,$
- $I_b = 1mA.$

Transistors to saturate in the ON condition.

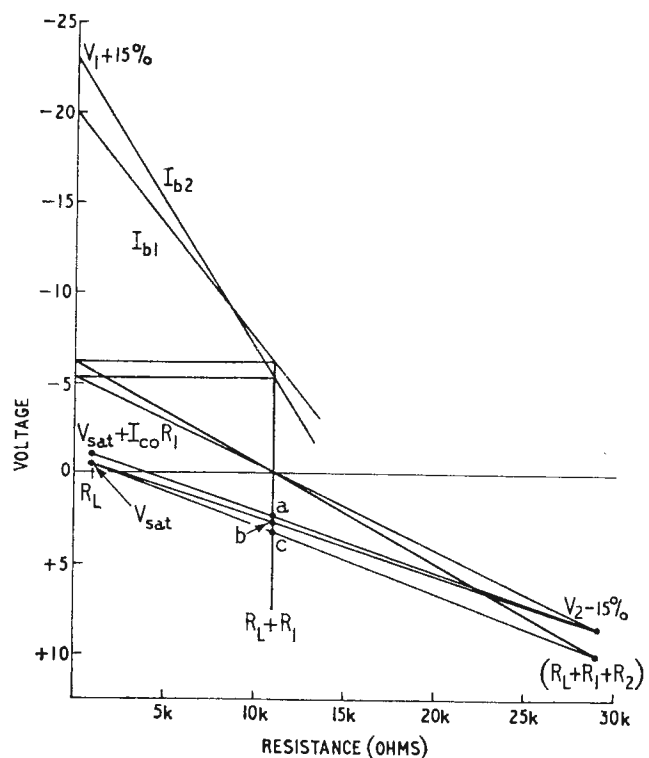

Fig. 5. Extension of Fig. 4 to obtain information on effect of tolerances.



Choose values for  $R_1$  and  $R_2$ , then find the following information:—

Under nominal conditions what is the maximum reverse base voltage? What voltage may  $V_2$  increase to before insufficient base current is obtained? What is the effect of changes of +15% in  $V_1$  and -15% in  $V_2$  on reverse base voltage and base current? What is the minimum reverse base voltage under these conditions?

Fig. 4 shows the construction. A suitable value for  $R_1$  is  $10k\Omega$  and this puts  $R_2$  between  $12.3k\Omega$  and  $26.5k\Omega$ . The value chosen was  $18k\Omega$  as this is a preferred value and puts  $R_1 + R_2 + R_L$  near the centre of the permitted range of values. The maximum value of  $V_2$  which can be tolerated with these resistances may be found by extending line B (which is

concerned with  $I_b$ ) to intersect with  $(R_L + R_1 + R_2)$ . The limiting value of  $V_2$  is given by this intersection and is +14.7V in this case.

For the sake of clarity the construction to obtain the other information required is shown in Fig. 5. Under "nominal" conditions the maximum reverse base voltage is given by point C on the line joining  $(R_L, V_{sat})$  and  $(R_L + R_1 + R_2, V_2)$ , in this case 3.25 volts. With variations in supplies this reverse voltage alters to 2.7 volts, point "b." The minimum experienced occurs when  $I_{co}$  is maximum and is given by point "a," 2.4 volts. The base current which flows with nominal supply voltage is given by constructing back from  $(R_L + R_1 + R_2, V_2)$  through  $(R_L + R_1, 0)$  to give  $I_{b1}$ , 1.25 mA. Similarly with varied supply voltages the base current is given by the slope of  $I_{b2}$  as 1.62 mA.

## BOOKS RECEIVED

**Radio-Electronic Transmission Fundamentals**, by B. Whitfield Griffith, Jr. A course of study, at an intermediate level, of the elements of radio frequency engineering at high powers. The book is primarily intended for those interested in r.f. transmission. Broadly divided into two aspects, the subjects covered include network theory and transmission lines, with aerials and transmitters in the second part. Higher mathematics are not used, the mathematics that are needed being introduced when necessary. Pp. 612. McGraw-Hill Publishing Co. Ltd., McGraw-Hill House, 95 Farringdon Street, London, E.C.4. Price 60s.

**Aviation Electronics Handbook**, by Keith W. Bose. This is a practical book, for the owner-pilot or service technician, on the operation and maintenance of a variety of airborne electronic equipment. Communications, navigation and instrument landing systems are described and a chapter covers air radar applications. American regulations for the establishment of servicing facilities are set out, and the final chapter gives guidance on the practical aspect of installation. Pp. 224. Howard W. Sams & Co. Inc., Indianapolis 6, Indiana, U.S.A. Price \$4.95.

**Photoelectric Control**, by Harvey Pollack. Written at technician level, the book first deals with the design, construction and operation of photocells, and then goes on to describe the use of these devices in conjunction with electromechanical relays. A section then follows on measurement and indication by photo-electronics. The semiconductor photocell and photo-transistors are discussed, and the final chapter describes some industrial applications of photo-electric control. Pp. 136. John F. Rider, Publisher, Inc., 116, West 14th Street, New York 11, N.Y. Price \$3.50.

**High Fidelity Home Music Systems (second revised edition)**, by William R. Wellman. This book was written with the layman music lover in mind. Most aspects of sound reproduction are dealt with. Information is provided for the home constructor and for those contemplating purchase of a complete system. Pp. 241. D. Van Nostrand Co. Ltd., 358 Kensington High Street, London, W.14. Price 51s.

**Newnes Radio Engineers Pocket Book**. Thirteenth edition, revised by A. T. Collins, contains wire gauges, design data and useful formulae. Pp. 180. George Newnes Ltd., Tower House, Southampton Street, London, W.C.2. Price 10s 6d.

**Electronisch Jaarboekje 1963**. Pocket diary (in Dutch) with 150 pages of technical information with rapid-access coloured identification of sections giving general formulae, basic circuits, aerial design, valve and data and general information. De Muiderkring N.V. Bussum, Netherlands. Price Fl. 2.95; plastic cover Fl. 0.50 extra.

**Loudspeakers, Theory, Performance, Testing and Design** by N. W. McLachlan, D.Sc. (Eng.). This classic work, published originally in 1934 by Oxford Univ. Press is now available in an unabridged paperback version issued by Dover Publications, Inc., 180 Varick Street, New York 14. Pp 399. Price \$2.25, or from Constable and Co. Ltd., 10 Orange Street, London, W.C.2., price 18s.

**Thermoelectricity**, by D. K. C. MacDonald. Unified treatment of the physical basis of various thermoelectric effects (principally in metals, but with some reference to semiconductors) in terms of modern solid-state theory. Pp. 133 including a three-page bibliography. John Wiley & Sons Ltd., Gordon House, Greencoat Place, London, S.W.1. Price 49s.

**Trägerfrequenz-Nachrichtenübertragungen über Hochspannungsleitungen**, by H.-K. Podszcek. Third revised edition of this textbook of carrier-frequency communications over high-voltage power supply lines. Pp. 191. Springer-Verlag, (1) Berlin-Wilmersdorf, Heidelberger Platz 3, Germany. Price DM36.

### B.B.C. Engineering Division Monographs

No. 42 *Apparatus for Television and Sound Relay Stations*, by P. A. Peachey, M.I.E.E., R. Tooms, D.I.C., A.C.G.I., B.Sc. (Eng.), A.M.I.E.E. and D. L. Stuart, Grad. I.E.E. describes translators, receivers and drive equipment used in later stages of the expansion of television and sound coverage.

No. 43 *Propagational Factors in Short-wave Broadcasting*, by L. J. Prechner, B.Sc., deals with problems of choice of frequencies for the B.B.C. external services and compares typical reception results with theoretical predictions.

No. 44 *A Band V signal-frequency Unit and a Correlation Detector for a VHF/UHF Field-strength Recording Receiver*, by G. J. Phillips, M.A., Ph.D., B.Sc., A.M.I.E.E., P. T. W. Vance, M.Sc. and R. V. Harvey, B.Sc., A.M.I.E.E., describes additional equipment for use with the field-strength recording equipment covered by Monograph No. 6.

All the above published by B.B.C. Publications, 35 Marylebone High Street, London, W.1. Price 5s each.

# Paris Components Show, 1963

FLOOR SPACE DOUBLED TO ACCOMMODATE INCREASED INTERNATIONAL SUPPORT

**I**N the advance publicity for this exhibition the French use the expression *une grande confrontation*, and this year the literal shade of meaning which suggests in English something of a "facer" was even more apparent. A new hall had been added, nearly doubling the floor area, and the number of stands had risen to 765, a 27% increase on last year. Of these, 342 were from countries other than France (e.g., Germany, 108; U.S.A., 91; U.K., 55; Italy, 22; Switzerland, 20). To visit every stand it was necessary to walk at least  $2\frac{3}{4}$  miles, and if one could have attended from 9.30 a.m. to 7 p.m. on each of the five days of the exhibition it would be possible to devote an average time of  $3\frac{3}{4}$  minutes per stand—that is if one did not stop for meals!

First impressions were quantitative—of the large

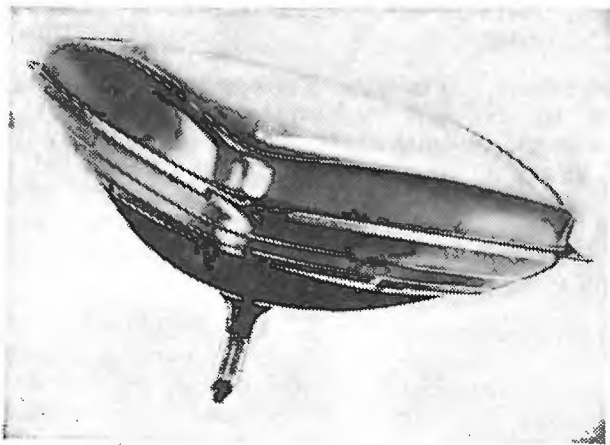

Telefunken A59-12W "anti-implosion" Television tube.

numbers of firms making similar products and of the strongly competitive character of the European component industry, not only in the fields of fundamental materials and components like resistors and capacitors, but also in sub-assemblies such as tuner units and switches. Developments like integrated semiconductor circuits, which were comparatively new last year, were to be found on the stands of most of the large manufacturers in this field.

A new development in television tubes is the introduction of "anti-implosion" types which were shown by three firms ("La Radiotechnique," Sovirel and Telefunken). In principle the stresses in the tube skirt, due to the air pressure on the curved face of the tube, are balanced by compressive forces applied either by a steel band or, as in the case of the Sovirel "Solidex" and the Telefunken A59-12W tubes, by two pressed steel shells clamped together. A softer bonding material between the band (or shells) and the glass distributes the stress evenly, and may be extended, as in the case of the La Radiotechnique "Auto-Protecteur" tube, over the rear cone as an added precaution. Films in slow motion were shown of a comparison between the deliberate destruction, by a striker pin, of tubes of the

old and new types, of the damage caused to the set by the former and the localized cracking, without general collapse, of the new design. Not only are the weight and cost of plate glass or plastic fronts eliminated, but it is claimed that much lighter cabinet construction can be used with safety.

Miniature (8-inch) television tubes with 90° deflection were on show by several manufacturers in anticipation, no doubt, of further numbers of small transistor portable television sets.

Double-beam tubes for oscilloscopes were much in evidence and a very low pattern distortion (1%) is claimed for the Type 1000H, 10-cm tube, shown by the M-O Valve Company, enabling the traces to be superimposed if required for accurate comparison. In the Type E 10-10GH 10-cm tube by "La Radiotechnique" an aluminized screen is used, enabling the advantage of increased brilliance to be retained for an e.h.t. of only 3 kV. The vertical sensitivity is 8V/cm. An interesting special oscilloscope tube (D7-16GJ) was announced by Telefunken. It is designed for use with transistor circuits and its heater is rated at only 80mA (6.3V); the anode potential is 800V. The overall length of the tube is only 154mm (6 inches) and the screen diameter 76.2mm (3 inches). Sensitivity is 22V/cm.

A reversible decade counter tube (ECT100) developed by Elesta S.A., Bad Ragaz, Switzerland, operates with inputs as low as 50V and is used with a transistor switching circuit which applies the pulses with alternating polarity to odd and even numbered cathodes, with which are associated staggered intermediate guide electrodes. Counting speeds up to 100 kc/s are claimed.

Among test and measuring instruments the v.h.f. and u.h.f. wobblers of Ribet-Desjardins were noted. Type 411A covers 0 to 320 Mc/s in three ranges with modulation depths of 7 Mc/s or 25 Mc/s, and Type 412A, in preparation, will extend the frequency from 350 to 950 Mc/s. Principal crystal-controlled frequency markers in the 411A are at 10 Mc/s intervals with smaller 1-Mc/s subdivisions, and the 412A will give additional fixed markers at 29.5 or 39.5 Mc/s. The new Hewlett-Packard 175A oscilloscope uses a c.r.t. with a parallax-free graticule (6cm x 10cm) on the inside of the non-glare optically-flat faceplate. Also shown by Hewlett-Packard was the Type 5243L eight-digit electronic counter with a time stability of 3 parts in  $10^9$  and a basic frequency range of 0-20 Mc/s. A plug-in frequency converter extends the range to 512 Mc/s.

For production line testing of diodes and transistors *in situ* in printed circuit boards the "Diotester," produced by Société d'Études, Recherches et Constructions Électroniques, Montrouge, Seine, is self-contained. Spring-loaded contact points, spaced to fit JEDEC (T0-5) bases, apply a small potential to the appropriate connections and indicate by a press button and lamp the cut-off and saturation conditions of transistors (n-p-n or p-n-p) and the conductivity of diodes. The instrument weighs 300gm (10oz) including a rechargeable

accumulator. Working on a similar principle the tester shown by American Electronic Laboratories uses a separate three-contact probe in conjunction with a rather more sophisticated test instrument, operating from the mains, and automatically running through a series of tests, including gain, with lamp indications of "go" and "no go."

It is appropriate that in France, the birthplace of Peltier, more than usual interest is being revived in that branch of thermoelectricity which deals with the cooling of metallic or semiconductor junctions by the passage of an electric current. Whatever may be the future of these devices in the domestic field, there can be no doubt of their present usefulness in the laboratory. In the Type 18/9 "Frigatron" unit made by Compagnie Industrielle des Ceramiques Electroniques (a subsidiary of C.S.F.) the junction is tellurium-bismuth and the unit forms part of a stable zero (Centigrade) temperature reference for the cold junction of thermocouples. "Le Zerofix," as it is called, maintains a water/ice equilibrium in a sealed vessel which can contain up to 6 junctions. The great advantage of the Peltier refrigerator is that the energy transfer is continuously variable, and L'Omnium de Techniques Avancées (an associate of Soc. Alsacienne d'Électronique et de Mécaniques Appliquées) have developed a thermoelectric module Type P8 which has been applied to the cooling of photomultipliers used in scintillation counters. Going from cold to hot, we find the same group (S.A.E.M.A.) showing equipment for producing high-power (3kW-50kW) electron beams for cutting, melting and vaporizing "difficult" materials in a vacuum.



Above: Double-beam oscilloscope tube, Type E10-10GH ("La Radio-technique").

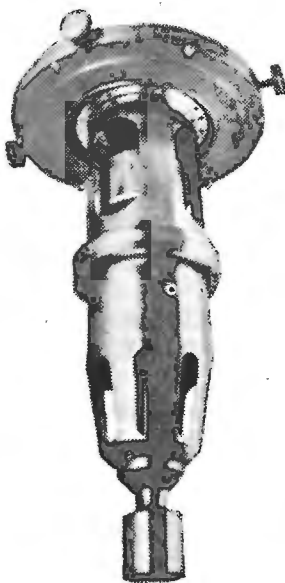

Right: 3kW electron "cannon" for narrow-beam bombardment of materials (S.A.E.M.A.).

Below: "Otechna" Type 8 thermoelectric module.

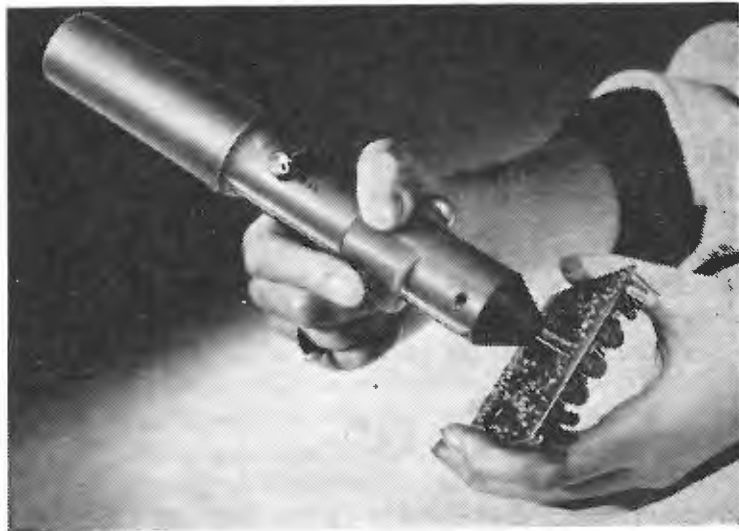
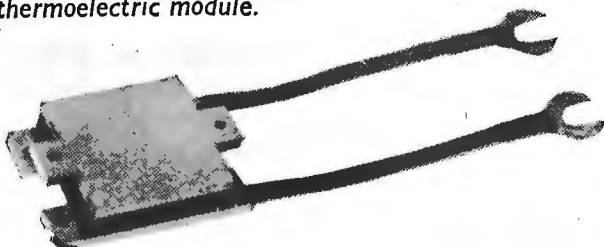

Diode and transistor Tester (S.E.R.C.E.L.)

In an annexe to the main part of the exhibition, under the title "L'Électronique Quantique," several firms were showing neon-helium gas lasers in operation. This was in support of a conference on lasers and masers held during the same week in Paris. Most of the equipment made use of metre-length tubes, but Philips demonstrated stable laser action at a wavelength of  $1.5\mu$  in a tube only 12cm in length, and with a d.c. discharge. A heavy cylindrical quartz block is bored with a hole 3mm diameter and dielectric infra-red reflecting end blocks are held on the optically flat and parallel ends of the tube by the vacuum. Tuning is by an external heating coil. After passage through polarizing elements the beam was detected in a photo-cathode and displayed by a closed-circuit television monitor to show the possible modes of operation.

Among audio exhibits a new electrostatic microphone, Type C 60, by A.K.G. was noted. It weighs only 60gm ( $2\frac{1}{8}$ oz) and can be supplied with a cardioid or an omnidirectional capsule (frequency responses 30-18,000 and 30-30,000c/s respectively). The built-in pre-amplifier gives an output into 600 ohms of  $1.3\text{mV}/\mu\text{bar}$ . Power supply is from mains or a rechargeable battery unit, the latter giving 14 hours continuous service.

An ingenious magnetic tape mechanism known as the "Tape-Top 305," shown by General Television, 17, Avenue de Paris, Vincennes (Seine), is designed to fit on a gramophone turntable (78 r.p.m.) and gives in the standard form, 4 hours playing time on two tracks of a 2,200ft continuous loop  $\frac{1}{4}$ in tape. The tape is stored on a shallow conical plastic base 12in diameter and 2in deep, fitted with a dust cover, and the tape feed mechanism and record/replay head are mounted at the centre, and can be adjusted vertically to select the appropriate track. With a special head up to six tracks can be recorded, and played back separately or simultaneously. Using thin ( $25\mu$ ) recording tape a maximum playing time of 24 hours is possible, using the six tracks. The weight of the unit is only 3lb.

The growth of the *Salon International des Composants Électronique* since it changed six years ago from a national to an international exhibition has been phenomenal. It has now reached a critical state of development when a decision must be made, either to limit its size, or to extend the period of opening. This year the material present was sufficient to overwhelm the most hardened "exhibition addict."

# Citizens' Radio in U.S.A.

DOES BRITAIN REALLY WANT SUCH A SERVICE ?

By R. L. CONHAIM\*

**T**HERE has been a lively discussion in the pages of *Wireless World* on the pros and cons of a Citizens' Radio Service for Great Britain. Experience in the United States, Canada and some of the Central American countries has been cited as the basis for some of these arguments. But, no one could possibly know what the services in these countries are like, without having experienced them. The experiences gained within the United States should be valuable to both those proposing and opposing such a service for Great Britain, for there are now more than 350,000 Citizens' Radio† licensees within the U.S.A., most of them utilizing the Class D or 27-Mc/s band. The actual frequency range is 26.96-27.23 and 27.255 Mc/s with a maximum "plate power" of 5 watts.

## Case History

A little background may be of value. Prior to 1958, there existed in the U.S. a Citizens' Radio Service, divided into several classes. Voice communication, however, was limited to the 465-Mc/s band, and there were very few users, due to the propagation characteristics of this band. The other classes were for radiotelegraphy, and for the radio control of models and other radio-controlled devices, where more than 100 milliwatts of power was required. The Class A service, that around 465 Mc/s, attracted little attention. The few transceivers produced for this service were limited in range to about a mile, except over particularly good terrain.

Then in 1958, the Federal Communications Commission opened the relatively unused 11-metre amateur band (around 27 Mc/s) for Citizens' Radio voice communication. The results, at first, were not startling. There was no great rush to apply for licences. Potential manufacturers of equipment adopted a wait-and-see attitude. Then, about the middle of 1958, an article on how to build a Class D (27 Mc/s) Citizens' Radio transceiver was published in a radio journal. The article stirred an immense amount of interest, especially among those frustrated amateurs who knew a little about radio but never had enough ambition to learn the code and the necessary technical information to secure an amateur transmitting licence. Parts stockists were besieged by enthusiasts eager to build this transceiver, which comprised a simple transmitter and a super-regenerative receiver.

That's when the fun began. Bear in mind that most of the original Class D licensees were essen-

tially hobbyists. They used the new band for hobby purposes, and fostered the same kind of use by newcomers to the band. The F.C.C. regulations, which had been written in the usual official language, were completely misinterpreted, often wilfully, and Class D became another amateur band, but without the benefit of amateur licensing. One of the rules stated that the band was for short-distance communications for the business or personal business of the licensee. "Short distance" was interpreted by these early users as anything less than 3,000 miles! and during exceptional propagation conditions DXing was the rule rather than the exception. "Personal business" was interpreted as almost anything. Some owners considered hobby use as personal business. One licensee, to whom the author talked, said the regulations set up the band for business or "pleasure," and, after all, he was only using the band for his personal pleasure!

The F.C.C., with only a few monitoring stations, and limited personnel, realized they had a bear by the tail. There was little they could do about it. New licences were accompanied by instruction sheets, detailing somewhat more specifically the "do's" and "don'ts," and defined more specifically some of the regulations.

The requirement that only holders of professional licences (first- or second-class commercial radio-telephone) should undertake transmitter adjustments was ignored almost completely. Users adjusted transmitters at will, ignored the 5-watt input limitation and "souped up" even commercial transceivers to radiate much higher power than authorized. Any evening you wanted to monitor the band with a frequency meter, you would find that at least half the stations were off frequency. The tolerance of 0.005% was met by few users. The demand for crystals to operate on the 22 channels (now 23) became so great that some crystal manufacturers weren't always too careful about what they supplied.

The band was now becoming really wild. During the daytime hours, it was relatively quiet, except for business use, but at night the screeching, howling heterodynes made the 80-metre amateur band sound like a school room at midnight. Long-winded discussions tied up channels and prevented legitimate users from gaining any benefits from the service. Incidentally the minimum age for a Citizens' Radio licence is 18.

In early 1961 the author visited an F.C.C. secondary monitoring station and it was obvious there were so many violators, and so few monitoring people, that only a small percentage of the errant users ever received citations for their wrong-doings. Reports of television interference increased rapidly, from neighbours of Citizens' Band operators.

\* Dayton, Ohio, U.S.A.

† Defined in the F.C.C. regulations as "a radio communication service of fixed, land, and mobile stations intended for personal or business radio communication, radio signalling, control of objects or devices by means of radio and other purposes not specifically prohibited in this part."



The licensing activity, in the meantime, had picked up so enormously, that the "W" numbers which had sufficed for years were exhausted. In 1960 "A" numbers, then "B" numbers were used. In 1961 "Q" numbers were used, then "QA" numbers. And in 1962 a three-letter system was inaugurated.

Equipment manufacturers were now in high gear. You could have your choice of kits or built-up transceivers for prices ranging from \$40.00 to about \$200.00, or roughly £13 to £70. The accessory manufacturers were reaping great profits as well. All manner of special antennas appeared, both for mobile and fixed base stations. Field strength meters, power output meters, standing wave bridges, crystal activity testers, wavemeters, frequency meters, dummy loads and a hundred other items appeared on the market and were gobbled up by ardent C.B. fans.

At this point the F.C.C. realized it would have to modify and clarify its regulations governing the Citizens' Radio Service. Conversations were limited to 5 minutes, kit manufacturers were required to seal the frequency-determining circuits of transmitters, DXing was strictly forbidden. But the users outnumbered the regulators by such tremendous margins that the new regulations had little, if any, effect.

### The Present Position

Now the F.C.C. is proposing new regulations, spelling out in detail, what they expect of the band, what a user can do and cannot do. The language is more clear, more specific. Licence applications are receiving closer scrutiny, to be sure the applicant has a legitimate reason for his licence. New requirements cut the conversation limit to three minutes, followed by a five-minute silent period. More stringent rules are being applied to set manufacturers, especially the kit manufacturers. Only

five of the 23 channels are proposed for interstation use. The remaining channels are set aside for communications between stations of the same licensee, or for emergency and Civil Defence communications. All of the proposed new regulations will help to get a measure of order out of the chaos which now exists. But the final answer must of necessity come from self-regulation.

The idea of self-regulation is difficult. Users cannot, for example, report conversations to the F.C.C., for the Communications Act of 1934, under which the F.C.C. operates, forbids the revealing of message content to anyone except the person for whom the message was intended. The formation of Citizens' Band Clubs and associations has become wide-spread. Many of these are making honest attempts to clean up the band, while others are out to promote the idea of making C.B. a hobby.‡

That brings us back to the question, "Does Great Britain Want a Citizens' Radio Service?" Apparently many British citizens do. The idea is basically sound—if it gets off on the right foot. But a Citizens' Radio Service should be set up only to provide a basic communications need. Benefiting from the mistakes made in the U.S., all hobby activities of any kind should be specifically forbidden. There should be tighter controls than we in the U.S.A. have over the manufacturers of equipment. Probably specific frequency assignments for specific purposes would prevent much of the "hamming" with which we have had to contend.

By all means, if you want a Citizens' Radio Service, set one up. But avoid our mistakes. And make your restrictions tight enough that they can be reasonably enforced. Go into it slowly and carefully, and come up with a service that really gives the average citizen a communications medium that will serve him and his fellows well.

‡ A new communication jargon has emerged; "10-4" means message received and "10-7", signing off.—Ed.

## H.F. PREDICTIONS—MARCH

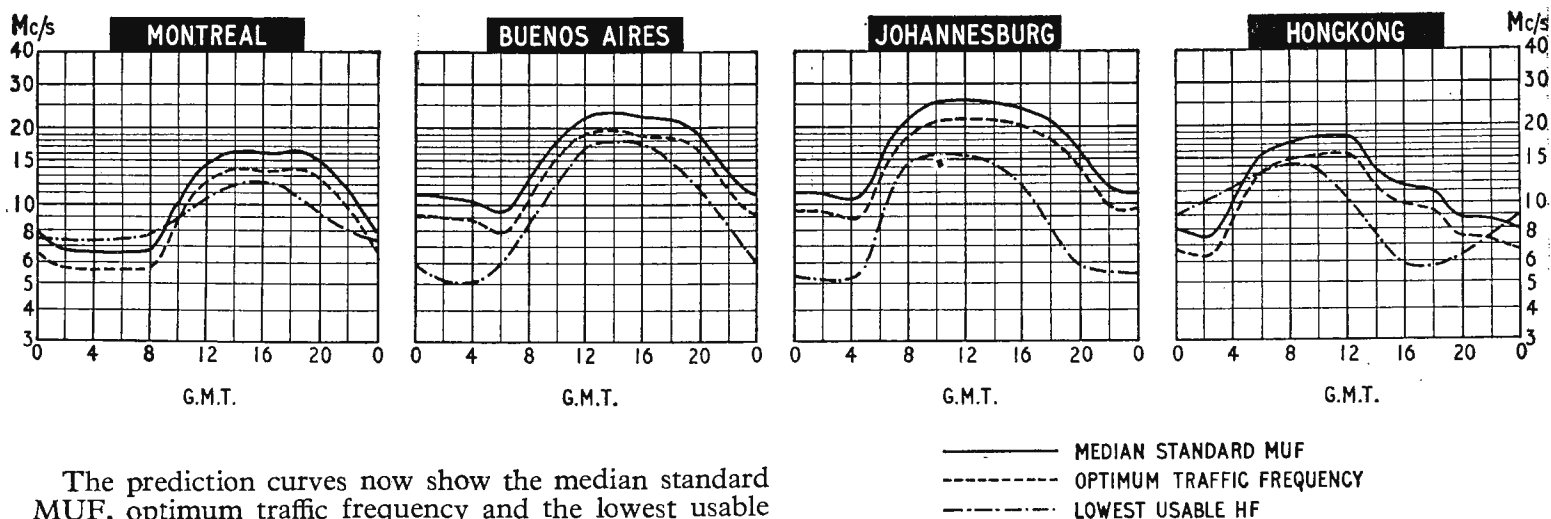

The prediction curves now show the median standard MUF, optimum traffic frequency and the lowest usable high frequency (LUF) for reception in this country. Unlike the MUF, the LUF is closely dependent upon such factors as transmitter power, aerials, local noise level and the type of modulation: it should generally be regarded with more diffidence than the MUF. The LUF curves shown are those drawn by Cable and Wireless,

Ltd., for commercial telegraphy and they serve to give some idea of the period of the day for which communication can be expected. The LUF curve for Montreal takes account of auroral absorption.

# WORLD OF WIRELESS

## U.H.F. Television Tests

THE second stage of the B.B.C.'s field trials of 625-line u.h.f. television began on February 1st when simultaneous transmissions on two channels (34 and 44\*) were started from Crystal Palace, London. Transmissions, employing an e.r.p. of 160 kW with horizontal polarization, are radiated from 10 a.m. to 5 p.m. and from 8 p.m. to 9.30 p.m. daily from Monday to Friday. They include test patterns, slides and films in monochrome and in colour, including a colour film between 12.50 and 1.15. During February the N.T.S.C. system has been used for the colour transmissions and in March trials will be conducted with Secam.

Tests will continue until towards the end of the year, after which preparations will be made for the start of the B.B.C.'s second television service scheduled for next April. Incidentally, we understand there is no foundation for the recent rumour that the two channels now being used experimentally will continue to be used for London when the new service starts.

\*Channel 34, vision 575.25 Mc/s, sound 581.25 Mc/s. Channel 44, vision 655.25 Mc/s, sound 661.25 Mc/s.

## Balance of Trade

IMPORT-EXPORT figures for 1962 culled from the Board of Trade accounts reveal that while there was a 10% increase in the value of exports of radio and electronic equipment, imports increased by over 17%. The year's exports totalled nearly £76M compared with £69M the previous year and imports were £31.6M as against £27M in 1961. Incidentally the value of receiver imports last year exceeded exports by nearly £1M.

The main increases in imports were in transmitting equipment and navigational aids £8.6M compared with £6.7M, domestic and car receivers £2.3M (£1.4M), instruments £4M (£3M), valves and c.r. tubes £4.8M (£4.4M) and transistors £1.6M (£1.2M).

From the table below can be seen the variations in the value of U.K. exports for the past two years.

	1961	1962
Transmitting equipment and Nav aids ...	21.42	23.50
Valves and c.r. tubes ... ..	9.94	11.68
Components ... ..	14.84	14.14
Instruments and test gear ... ..	11.79	14.22
P.A. gear, loudspeakers and mikes ... ..	1.17	1.27
Domestic sound receivers and radiograms ... ..	2.23	1.38
Domestic television receivers ... ..	1.55	3.47
"Other radio and television apparatus" ... ..	2.78	3.71
Electro-medical apparatus ... ..	0.45	0.43
Electronic control equipment ... ..	2.50	2.28
	£68.67M	£76.08M

## Standard Frequency Transmissions

SINCE 1945 the 200-kc/s carrier frequency of the B.B.C.'s light programme transmitter at Droitwich has been stabilized and is now maintained to within 5 parts in 1kM. The diurnal rate of frequency change is not greater than +1 part in 10kM and the resultant error is now being corrected each month. The new carrier frequency generators at Droitwich employ Essen type quartz rings operating at a nominal frequency of 100-kc/s. These quartz rings were provided by the Post Office and operate in equipment supplied by Airmec.

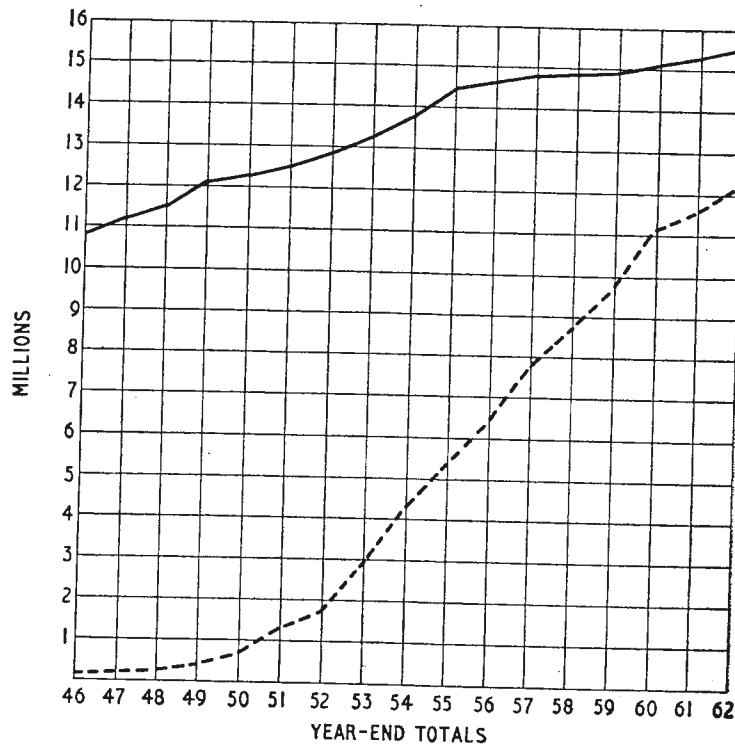

**Broadcast Receiving Licences.**—The increase in television licences over the past 17 years is shown by the broken curve. The December increase of 6,684 brought the number to 12,230,987. The overall total of sound and television licences is shown by the full curve; the December total being 15,580,400, including 526,549 for radio sets fitted in cars.

## P.A. Show

THE annual exhibition of public address equipment organized by the Association of Public Address Engineers will be held at the King's Head Hotel, Harrow, Middlesex, on March 6th and 7th. Demonstrations of stereo recordings are being staged by several companies and the B.B.C. Admission to the show, open from 10.0 a.m. to 6.0 p.m. each day, is by invitation ticket obtainable from the A.P.A.E., 394 Northolt Road, South Harrow, Middlesex, or by business card. This year's exhibitors include:—

Ampex	Pamphonic Reproducers
Audix	Philips Electrical
B.B.C.	Politechna (London)
C.T.H. Electronics	Pye Telecommunications
E.M.I. Electronics	Reosound Engineering
Film Industries	Resosound
Goodmans	Shure Electronics
Grampian Reproducers	Sound Coverage
Lockwood & Company	Standard Telephones & Cables
Lustraphone	Vortexion
Magneta	Westrex Company
Mullard	Williams Cine and P.A. Services
	Warren, Haydon

**Stereophonic Transmissions.**—In addition to the series of stereo transmissions on Sundays, Wednesdays and Saturdays from the Wrotham station announced in our last issue, the B.B.C. has now introduced weekly tone test transmissions. These will be radiated at midday on Wednesdays from 12.0 to 12.30. A schedule of the tone transmissions is given in Information Sheet 1602, obtainable from the Engineering Information Department, B.B.C., Broadcasting House, London, W.1.

**Paris Radio Show.**—The dates have now been announced by the Fédération Nationale des Industries Electroniques for the International Radio and Television Exhibition to be held in Paris in September. They are 5th to 15th.



**Apprentice Prize Winners.**—D. Brooker, a Marconi craft apprentice, won the premier award—the Silvanus P. Thompson prize—in the Physical Society's Apprentices Competition, and also the first prize in the senior grade of scientific instruments and components for his sun shutter and filter drive mechanism for use in closed-circuit television. The other four Marconi entrants also received awards. They are craft apprentices V. L. Cathcart, for his spot wave selector for a communication transmitter; T. H. Lodge, flywheel synchronizing panel for a broadcast television recorder; P. J. Howe, a joystick control assembly for use with radar display consoles; and C. L. Chadwick, inner chassis assembly for a marine radio receiver. A trainee at the Company's Basildon Works, M. A. W. Golding, gained an award for his entry of a printed circuit board assembly for a television test pattern generator.

**T.E.M.A. Awards.**—The annual awards in the competition for the best final-year apprentice of the member firms of the Telecommunication Engineering & Manufacturing Association were made by the chairman, W. G. Patterson, of A.E.I., at the Association's annual dinner on February 12th. The recipients, who each received £25, were P. H. Morecombe, B.A. (G.E.C.), graduate-in-training; D. G. Hornby, Dip.Tech. (A.T.E.) and M. A. Woods (A.E.I.), who tied for the student apprentice award; and T. R. J. Hill (A.T.E.), technician apprentice.

**R.S.G.B. Contests.**—The first of this year's contests organized by the Radio Society of Great Britain will be held this month. On March 2nd and 3rd there will be the 144 Mc/s Open and Listeners' V.H.F. Contests, and on the 16th-17th the first 1.8 Mc/s contest. The full list includes a number of qualifying events leading up to the National D/F Final on September 15th. The National Field Day will be on June 8th-9th and the V.H.F. Field Day on September 7th-8th.

After five days of test transmissions for the trade, the Independent Television Authority commenced programme transmissions from its **Moel-y-Parc** station (Channel 11, vertically polarized) located on the borders of Flintshire and Denbighshire, North Wales.

The **Soviet Union economic target** for 1962 was exceeded and according to preliminary estimates industrial output was 9½% higher than the previous year. There was little increase in the production of radio sets and radiograms (4.3M), but production of television sets (2.2M) showed an 11% increase over last year's figure.

**G6SL**, the call sign of the amateur station operated at the Eddystone Works, Birmingham, has recently been used illicitly. This has been confirmed by the receipt of a number of QSL cards.

**New laboratories** for Racal Electronics were opened at Bracknell, Berks., by Mr. Julian Amery, Minister of Aviation, on February 12th. The new research and development laboratories, occupying approximately 24,000 sq ft, bring Racal's total floor area to 150,000 sq ft. Since the company moved to Bracknell in 1954 its staff has increased tenfold and is now approximately 1,000.

"**Assembling Radio Valves**" is the title of a new film in the B.B.C. Schools TV series "Going to Work." It deals with a teenage girl who chooses to work in electronics and light electrical engineering. The programme is to be transmitted on March 4th and 5th and viewers will see her going through the normal selection procedure, receiving instruction in a training school and finally making valves for use in industrial electronic equipment. The film was shot at Mullard's factory at Mitcham.

A combined symposium and exhibition on **environmental testing** is to be held on 27th-30th March, at the Imperial College of Science and Technology, South Kensington, London, S.W.7. The symposium will include the presentation of twenty-three papers, many of which will be of direct interest to those concerned with reliability. Full details can be obtained from the secretary of the Society of Environmental Engineers, 167 Victoria Street, London, S.W.1.

**Anglo-American consortium** of companies has been appointed by the South Arabian Federal Government to organize and operate a radio and television broadcasting system. The companies concerned are Thomson Television International (U.K.), National Broadcasting Company (U.S.A.) and Television International Enterprises (U.K.). A radio service is already in operation and it is hoped to have a 625-line television service operating by the end of the year.

**Trader Year Book.**—First published in 1925, the "Wireless and Electrical Trader Year Book" is an indispensable reference book to the radio and domestic electrical industries. The 1963 edition, which costs 21s and comprises 444 pages, includes all the sections which have proved so useful in the past, such as the buyers' guide; condensed specifications of current sound and television receivers, radiograms and tape recorders; valve, c.r.t. and transistor connections; receiver i.f.s and a directory of manufacturers.

**R.F.C.W.O.O.C.A. Dinner.**—The Royal Flying Corps Wireless Operators Old Comrades' Association is to hold its annual dinner in London on March 30th. Details are obtainable from E. J. F. C. Hogg, 57, Hendham Road, London, S.W.17. (Tel.: BALham 6963.)

**Professional Engineers.**—The inaugural meeting of the South-East Essex Society of Professional Engineers will be held at the Queens Hotel, Westcliff-on-Sea, at 8.0 on March 1st. Particulars are obtainable from E. W. Marsden, 21 Somerset Avenue, Westcliff-on-Sea, Essex.

**Semiconductor Applications.**—A two-day course on recent advances on semiconductor applications is being held at the Slough College, William Street, Slough, Bucks., on March 27th and 28th. The fee is 2 gn.

The latest **Dip. Tech. awards** bring up the total to over 1,800 since the introduction of the scheme in 1958 by the National Council for Technological Awards. There are now 7,292 students on courses.

## CLUB NEWS

**Birmingham.**—The Slade Radio Society has arranged a Mullard film meeting in the Great Hall of the Birmingham and Midland Institute, Paradise Street, Birmingham, at 7.45 on March 8th. On the 22nd J. E. Smith (G3JZF) will give the fifth of his series of lectures on radio fundamentals at The Church House, High Street, Erdington.

**Derby.**—"Car Radio; Interference Problems" is the title of the lecture to be given by R. Barrell (G3FOP) to members of the Derby and District Amateur Radio Society on March 13th. Meetings are held at 7.30 at 119 Green Lane.

**Edinburgh.**—At the March 14th meeting of the Lothians Radio Society M. Russell will give a talk entitled "History of Automobile Communications." On the 28th J. Hughes (GM3LCP) and T. Spiers (GM3OWI) will discuss electronics. The club meets at 7.30 at the Y.M.C.A., South St. Andrew Street.

**Prestatyn.**—J. T. Lawrence (GW3JGA/T), chairman of the Flintshire Radio Society, will talk about fault finding at 8.30 at the club meeting on March 25th. Monthly meetings are held at the Railway Hotel.

**Spenn Valley.**—The subject of the talk by J. Belcher, of the G.P.O., to members of the Spenn Valley Amateur Radio Society on March 7th is direction finding. The club meets fortnightly at 7.15 at the Grammar School, Heckmondwike.

# Personalities

**E. V. D. Glazier**, Ph.D., B.Sc., M.I.E.E., has been appointed by the Ministry of Aviation to a new post at the Royal Radar Establishment, Malvern, in which he will be responsible for the "co-ordination of military and civil systems work in the fields of airborne and ground radar, guided weapons and space research." Dr. Glazier, who is 50, has been director of scientific research (electronics and guided weapons) in the Ministry since 1957. He received his early training in electrical and mechanical engineering in industry and joined the Post Office in 1933. In 1942 he was transferred to the Signals Research and Development Establishment and in 1950 was put in charge of the Research Division at Christchurch.

**G. E. Bacon**, Ph.D., M.A., B.Sc., at present deputy chief scientific officer at the Atomic Energy Research Establishment, Harwell, has been appointed to a chair of physics at the University of Sheffield which he will occupy from next October. He will also assume the headship of the Department of Physics under a new scheme whereby each of the two professors will fill the post for three years. Dr. Bacon graduated at Emmanuel College, Cambridge, and in 1939 joined the Air Ministry. He eventually took charge of a group concerned with ground radar research and development at T.R.E. (now R.R.E.) at Malvern.

**G. C. Gaut**, M.A., B.Sc., has been appointed to the board of the Plessey Company, parent of the Plessey group of companies. He joined the Company after graduating at University College, Oxford, in 1934 and was appointed an executive director in 1951. He set up the Company's first laboratory at Ilford for research and development on technical processes for the manufacture of electronic components in 1937. This laboratory was moved to Caswell, Towcester, in 1940 and is now engaged in solid state research. In 1961 Mr. Gaut was appointed to the board of Semiconductors Ltd., a Plessey subsidiary.

**Kenneth W. Brittan**, Ph.D., B.Sc., D.Sc., who is 31, has been appointed chief engineer of W. G. Pye & Company, scientific instrument manufacturers of Cambridge. Dr. Brittan graduated at Nottingham University with honours in physics in 1952 and continued his studies at the Postgraduate Technical School of Optics in the Royal College of Science, London, where he obtained his doctorate.

**D. G. Smee**, M.B.E., Assoc.I.E.E., who joined Marconi's W/T Company in 1933 and has been manager of the Broadcasting Division since 1956, has been appointed assistant general manager of the Company. During the war he was first with the Royal Signals and then R.E.M.E., rising to the rank of major. The new manager of the Broadcasting Division is **T. Mayer**, who joined the Company in 1948 and has been sales manager of the division for the past five years. His successor is **F. J. Sidebotham**.

**S. Hill**, M.Eng., the new chairman of the Acoustics Standards Committee of the British Standards Institution, is also chairman of the B.S.I. committee on electro-acoustic transducers and is a member of the committee on acoustical terms and definitions. He was recently appointed chairman of the Acoustics Standards Committee of the International Organization for Standardization (I.S.O.). Mr. Hill is a senior engineer with Standard Telephones & Cables which he joined in 1919.

**N. H. Searby**, C.B.E., Ph.D., B.Sc. (Hons.), M.I.E.E., manager of Ferranti's Guided Weapons Department since 1951, has been appointed to the board. Dr. Searby, who is 52, graduated at Birmingham University where he also obtained his Ph.D. He joined Ferranti's as a radio engineer on leaving the University in 1932 and became chief radio engineer in 1941.

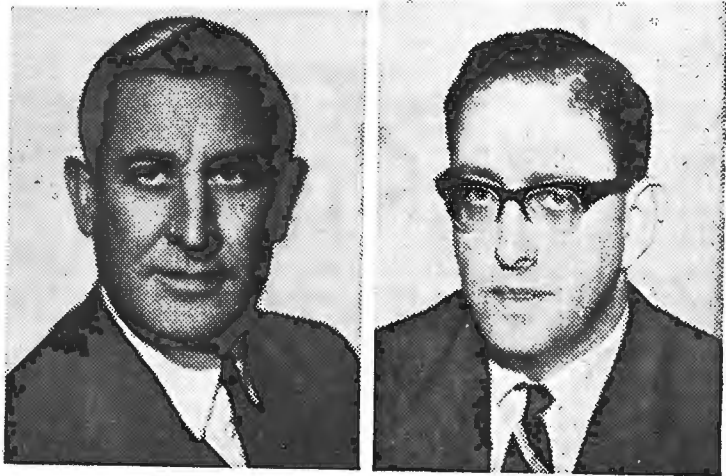

*Dr. N. H. Searby*

*P. R. Max*

**Peter R. Max**, B.Sc., A.M.I.E.E., has become chief engineer of the radar division of Cossor Electronics Ltd. and will control all development and systems engineering. He was previously manager of air traffic control and data handling in Marconi's Radar Division.

**Dr. Carlo L. Calosi** has been appointed to the board of Cossor Electronics Ltd., a subsidiary of Raytheon, U.S.A., of which he is a vice-president in charge of European operations. Dr. Calosi was at one time Professor of Electrical Engineering at the University of Genoa and later head of communications research with Ericssons. He went to the U.S.A. as head of Raytheon's research division at the end of the war. The appointment of **Leonard H. Weall** to the board of Cossor Electronics is also announced. He joined the Cossor group last year after spending several years with G. & E. Bradley Ltd., where he was works manager, having previously been with the Plessey Company.

**Bernard Marsden**, A.M.I.E.E., M.Brit.I.R.E., has been appointed deputy technical controller in the Engineering Department of Associated Television Ltd. and **Len Mathews**, M.Brit.I.R.E., to the newly-created post of head of special projects (technical). **T. C. Macnamara**, A.M.I.E.E., is ATV's technical controller. Mr. Marsden joined ATV in 1955 as senior engineer (installation and planning). He was promoted assistant controller of studios in 1958. Mr. Mathews also joined ATV in 1955 as senior engineer (communications) and has been assistant controller (communications and outside broadcasts) since 1958. He was previously in the B.B.C. Engineering Department.

**F. W. Alexander**, Ph.D., B.Sc., A.M.I.E.E., has been appointed superintendent engineer, sound broadcasting (equipment), in the B.B.C. Dr. Alexander joined the B.B.C.'s Engineering Research Department in 1933 from the research section of the Department of Physics of the University of St. Andrews. For the past few years he has been assistant superintendent engineer, sound broadcasting (studios).

**Dr. T. E. Allibone**, C.B.E., F.R.S., director of the Associated Electrical Industries Research Laboratory, Aldermaston, Berkshire, and director for research and education, A.E.I. (Woolwich) Ltd., has been appointed by the Royal Society to be Rutherford Memorial Lecturer in India and Pakistan, during a period to be arranged in the winter of 1963-64.

**G. G. Parfitt**, Ph.D., A.R.C.S., D.I.C., recently left the Department of Physics at the Imperial College of Science and Technology, London, and has gone to the University of Ibadan, Nigeria, as senior lecturer in physics. Dr. Parfitt, who has been at the College for about 15 years, spent a year at Göttingen University with Professor E. Meyer under an exchange arrangement. He has been concerned with acoustics research at the College including damping in polymers and noise problems. For the past four years he has been honorary secretary of the Acoustics Group of the Inst. P. and Phys. Soc.

**A. H. Appleyard**, A.M.I.E.E., A.M.Brit.I.R.E., has joined Avo Ltd. as senior electronics engineer and will deal with the design and development of electronic instruments. The company also announce the appointment of **G. Doye** as senior nucleonic engineer. He was previously with E.M.I. Electronics and on the laboratory staff of University College, London.

**Dr. Ernst Weber** has been elected as the first president of the Institute of Electrical & Electronic Engineers, formed by the merging of the A.I.E.E. and the I.R.E. Dr. Weber, who is president of the Polytechnic Institute of Brooklyn, was president of I.R.E. in 1959.

**Norman Caws** (G3BVG), is the new president of the Radio Society of Great Britain, of which he has been honorary treasurer since 1958. Mr. Caws is especially interested in v.h.f. and u.h.f. operation and has been closely associated with the London u.h.f. group since its formation in 1952. His brother **Raymond** (G3BRL) is chairman of the Radar & Electronics Association.

**D. J. Collins**, B.Sc.(Eng.), A.M.I.E.E., has been appointed divisional engineer responsible for research and development in the recently formed Data Recording Division of Consolidated Electrodynamics Corporation (U.K.) Ltd., of Woking, Surrey, a subsidiary of the Californian corporation of the same name. Mr. Collins, who is 35, was with E.M.I. for five years on missile work and since then with Solartron for ten years.

**John Bunton**, M.A., M.I.E.E., A.Inst.P., who joined Mullard in 1948 as scientific adviser to the board, has been appointed secretary of Mullard Ltd. Mr. Bunton was educated at Chesterfield School and Cambridge University where he graduated in natural sciences.

**Arthur S. R. Toby**, for the past 18 years engineer-in-charge of the North American office of the B.B.C., has joined Kramer Magnetics Ltd. of Port Credit, Ontario, Canada, as manager of the magnetic tape division.

## OUR AUTHORS

**Thomas Ormond**, author of the article on transistor bias networks in this issue, joined Sylvania in 1960 as an applications engineer in the Semiconductor Division and recently transferred to the Company's Electronic Systems Division. He is a graduate of Northeastern University, Boston, Mass.

**R. Thompson**, Grad.I.E.E., Grad.Brit.I.R.E., contributor of "Direct-coupled pulse circuits," studied for his I.E.E. graduateship at the North Gloucestershire Technical College and the Birmingham College of Advanced Technology. He has been in the telecommunications division of the Plessey Co. at West Leigh, Hants., since 1960 where he has been concerned mainly with S.C.R. and transistor high-power inverters. Before joining Plessey Mr. Thompson was with Dowty Nucleonics.

## OBITUARY

**Lord Hankey**, F.R.S., who died on January 25th at the age of 85, was chairman from 1941-1952 of the Technical Personnel Committee of the Ministry of Labour and National Service which was given the task of organizing the scientific manpower of the country. In 1943 he was appointed chairman of the Government Television Committee set up "to prepare plans for the reinstatement and development of the television service after the war." It was on the Hankey committee's recommendation that the 405-line service was re-established rather than defer the restarting "for the uncertain period required to give an opportunity of incorporating some fundamental improvement in the system."

**Sir Isaac Shoenberg**, M.I.E.E., leader of the team of engineers and physicists at E.M.I. which was responsible for the development of the 405-line television system, died on January 25th at the age of 82. Born in Pinsk, Russia, he was chief engineer of the Russian Wireless Telegraph and Telephone Company, Leningrad, from 1905 until he came to this country in 1914 as a consulting engineer to the Marconi Company of which he later became joint general manager. Sir Isaac, who was knighted last year "for services in the development of television and sound broadcasting", joined the Columbia Graphophone Company as general manager in 1928 and, when it merged with the Gramophone Company in 1931 to form E.M.I. he became director of research. In 1954 he received the Faraday Medal of the I.E.E. "for . . . the outstanding contributions which he has made to the development of high-definition television in this country".

**J. H. Dellinger**, Ph.D., Sc.D., of "Dellinger Effect" fame, died on December 28th aged 76. He was chief of the Central Radio Propagation Laboratory of the U.S. National Bureau of Standards on his retirement in 1948 after over 40 years' service with the Bureau. He graduated at the George Washington University and obtained the Ph.D. degree from Princeton University in 1913. In 1932 his Alma Mater honoured him with the Sc.D. degree. Dr. Dellinger was an international figure in the world of wireless, especially in the field of propagation, and he had represented the U.S.A. at numerous conferences. He was the first chairman of the C.C.I.R. study group VI concerned with propagation, a position he held for many years.

**Laurence B. Turner**, M.A., Sc.D., M.I.E.E., a fellow of King's College, Cambridge, who died on January 28th aged 76, was at the Army Signals Experimental Station during the first world war and at the Admiralty Signals Establishment throughout the 1939-45 war. In the intervening years he was director of studies in engineering at King's College, Cambridge, and was closely associated with W. H. Eccles in the development of the Commonwealth chain of long-wave communication stations. After the second world war Dr. Turner returned to Cambridge for research work and in 1948 was appointed a University Reader.

**Stephen Oswald Pearson**, B.Sc., D.F.H., M.I.E.E., who will be remembered by many of our older readers as a frequent contributor to *Wireless World* in pre-war days, died on January 18th aged 67. Born in South Africa, he was educated at Faraday House Engineering College, London, where, after training with Metropolitan-Vickers, he stayed throughout his academic career. He became senior lecturer, head of electrical engineering section and superintendent of the electrical laboratories at the College.

**C. H. Lamborn Edwards**, A.M.I.E.E., the well-known operator of amateur station G8TL of Theydon Bois, Essex, died suddenly on January 31st at the age of 61. He had been a member of the council of the Radio Society of Great Britain for nearly 20 years and was chairman of the "mobile" committee of the committee of the Radio Amateur Emergency Network.

# News from Industry

**Masteradio** trade name is being revived by G.E.C. and will be used for a range of television and sound radio receivers, radiograms and tape recorders. Masteradio Ltd. was acquired in 1960 by Radio & Allied Industries (Sobell and McMichael) which is now part of the G.E.C. organization.

**Peto Scott** television receivers are to be marketed by Stella Radio & Television Co. The servicing of Peto Scott sets will continue to be carried out by Amalgamated Electric Services Ltd., of Croydon.

**Muirhead.**—A record trading profit of £752,253 for the year ended last September, which was 73% more than the previous year, is recorded by Muirhead & Co. The net profit, after taxation (£389,812) and "retentions for subsidiaries," was £259,791.

**AEI Automation Ltd.** has been formed by Associated Electrical Industries Ltd. to concentrate the development and supply of industrial automation systems in a single company. A.E.I. has acquired Davy-Ashmore's interest in Steelworks Automation Ltd., hitherto a jointly owned company, which will now be amalgamated with AEI Automation. Headquarters are at Booths Hall, Knutsford, Cheshire.

**Universal Capacitor Co. Ltd.**, of Swindon, has been acquired by the London Electrical Manufacturing Co. All enquiries should in future be sent to Bridges Place, Parsons Green Lane, London, S.W.6.

**Derritron.**—The names of five subsidiaries in the group have been changed to incorporate the word Derritron. New names, with the old name in brackets, are Derritron Research and Development Ltd. (Beme Research and Development), Derritron Ultrasonics Ltd. (Chapman Ultrasonics), Derritron Instruments Ltd. (Doran Instrument Company), Derritron Electronic Vibrators Ltd. (Electronic Vibrators), Derritron Transformers Ltd. (L.S.B. Components).

Television and sound distribution in the new Hilton Hotel, London, has been installed by **British Relay Wireless Limited**. The relay system, which serves every guest room, has provision for six sound channels and six vision channels. There is also a public address system and to facilitate the transmission of outside broadcasts from the hotel a microwave link to the Post Office Television Centre is installed on the roof.

**Decca Radar** announce their 13,000th marine radar order—for a new tanker of 68,000-tons d.w. for the Tidemar Corporation of U.S.A. In 1962 they achieved a record number of 1,355 radar sales of which over 80% were exported.

A **three language** sound reproduction system used in conjunction with one film projector was devised by Williams' Cine & P.A. Services, of London, S.E.23, for an international audience at Dusseldorf. Three synchronized sound tracks, in English, French and German, were fed into a Multitone induction transmitting system so that members of the audience equipped with small switchable receivers could hear the commentary of their choice.

**Anglo-French Link.**—A reciprocal marketing agreement has been concluded between G. & E. Bradley Ltd., of London, and Société Ribet-Desjardins, of Montrouge (Seine). Ribet-Desjardins are leading French manufacturers of precision electronic measuring equipment, and their range of products is now available in the U.K. through G. & E. Bradley.

**Perdio**, who have specialized in the manufacture of transistor portables, have acquired Electric Audio Reproducers, manufacturers of radiograms, record reproducers and tape recorders.

**Raytheon.**—Walmore Electronics Ltd. have been appointed by the Raytheon-Elsi organization as sole U.K. distributors of valves, microwave tubes, microwave components, semi-conductors and allied devices made by Raytheon in the U.S.A. and its subsidiaries, Machlett and Trans Sil Corp. The products of Raytheon-Elsi in Europe are also included.

**Vinylaz.**—Baulma & Co. Ltd., of 16 Berkeley Street, London, W.1, have been appointed by Société Belge de l'Azote et des Produits Chimiques du Marly, of Liège, Belgium, exclusive distributors for their range of Vinylaz unplasticized p.v.c. film and foil in the British Isles. Among its applications is the manufacture of sound recording tape.

**Aero Electronics Ltd.** are appointed the sole United Kingdom agents and distributors for Owen Laboratories, Inc. of Pasadena, Cal., manufacturers of semiconductor test sets.

**Solid tantalum capacitors** of J and N polar and non-polar types are now being manufactured by the Kemet Division of Union Carbide Ltd. at their Aycliffe, Co. Durham, works. All capacitors are being made to the U.S. military specification number MIL-C-26655A.

## OVERSEAS TRADE

**Tactical control radar system** for Australia's first surface-to-air guided missile unit, equipped with the Bristol/Ferranti Bloodhound, has been supplied by Decca. The complete system is built into a series of air transportable cabins.

**Travelling-wave tubes** for use on the 3,300-mile Montreal-Vancouver microwave communications link of the Canadian Pacific and Canadian National Railways have been ordered from Mullards. The t.w.t.s., valued at \$0.5M, will be used in R.C.A. Victor equipment.

**O.B. vehicles** for the television service of Radiodiffusion Television Belge are being supplied by Marconi's through their Belgian agents Société Anonyme Internationale de Télégraphie sans Fil. There will be four production vehicles containing the control equipment and monitors, and four technical vehicles each with a 4½in camera and associated equipment. Both 625 and 819 line standards are employed.

**Storm warning radar**, supplied by Cossor Electronics and mounted 2,000ft above sea level on Saddle Mountain in North Queensland, is being used by the Australian Bureau of Meteorology. The equipment is radio controlled from Cairns Airport seven miles away and the radar information is transmitted to the airport by a microwave link.

**Colour television** projection equipment to the value of £6,000 is being supplied by Rank Cintel for the University Medical College, Tokyo.

**Television studio equipment**, comprising cameras, sound and vision mixers, pulse generators and teleciné units, has been supplied for the Brazzaville station by Pye T.V.T. Ltd. in conjunction with Société Française des Techniques Pye.



With this issue, *Wireless World* embarks on a new series of articles on the construction and use of electronic equipment. The intention is to describe, in the first few articles, a group of measuring instruments (signal generators, voltmeters, oscillators, etc.) so that the reader will be well supplied with test gear before starting work on other projects to be described that may appeal to him.

Throughout the series we will have in mind the fact that the average home constructor does not have extensive workshop facilities, and will design for construction by simple hand tools only. Cost will be kept down to the lowest possible figure, while retaining high performance, using standard commercial components.

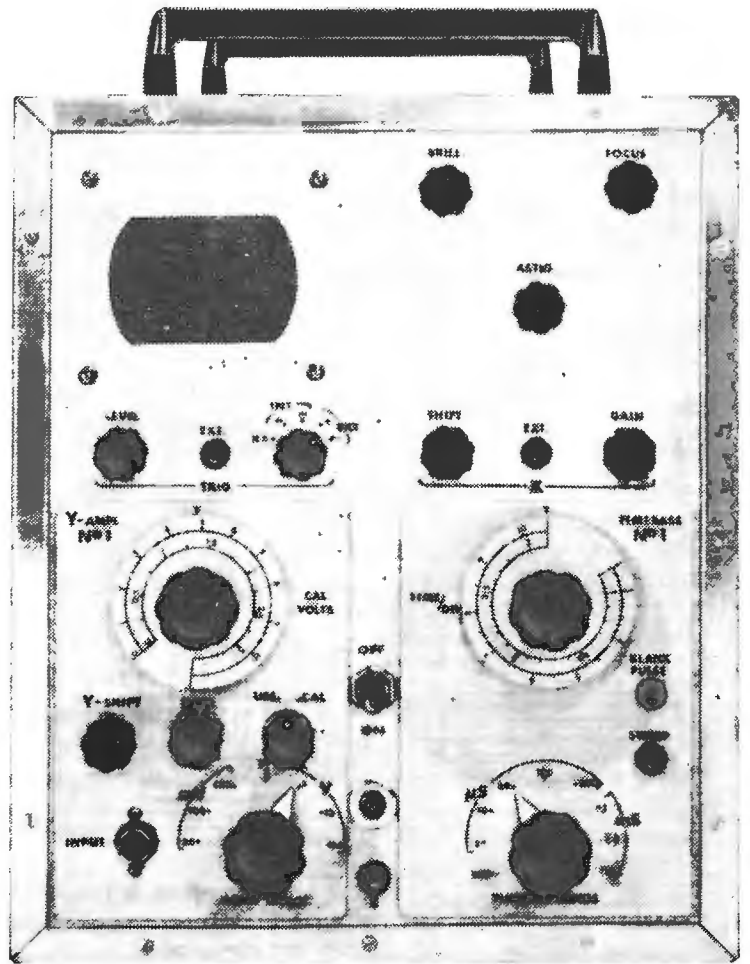

# Wireless World

## OSCILLOSCOPE

THE oscilloscope has long passed the stage at which it was used to display only the shape of voltage and current waveforms, and even the least sophisticated instruments now make some effort to provide voltage and time measurement. Any instrument designed for the home constructor must therefore afford these facilities, and possess as good a general performance as cost will allow. The resulting equipment, for the newcomer to the art, can be a somewhat daunting array of knobs, dials and excrescences, and it is felt that a short discussion of fundamentals will be useful. Techniques in general will be described, with particular reference to those used in our design. Next month's article will be devoted to constructional details of the oscilloscope.

### Principles

The essentials of an oscilloscope can be reduced to three functions, shown in Fig. 1. The  $y$  amplifier is required to deflect the cathode-ray tube (c.r.t.) trace in the vertical direction, and is so called because the display corresponds to an ordinary  $x/y$  graph, and the  $y$  axis is usually the vertical one. The timebase or sweep generator deflects the trace in the  $x$ ,

horizontal or time direction, and any amplifiers concerned with it are called  $x$  amplifiers. The third essential is the c.r.t. itself. This is a smaller, somewhat modified version of the one in the "telly," and although the spot traces out only one line instead of 405 or more, the programmes are frequently much more entertaining. As the spot progresses across the tube from left to right under the influence of the timebase generator, it is subject to a voltage from the  $y$  amplifier which moves it up and down, so that the display, Fig. 2, is a voltage/time graph. The average instrument is far from being as simple as this, but these three are basic, and the rest are refinements.

### Vertical Amplifiers

Having stripped our oscilloscope down to its bare bones, we can now begin to put the flesh back again, and, as the first part the signal encounters is the  $y$  amplifier, this is where we can start. The simple function of amplifying the  $y$  signal enough to operate the c.r.t. is attended with so many snares and delusions for the unwary, that the performance of this part of the circuit is usually the limiting factor in the design. Many different forms of ampli-

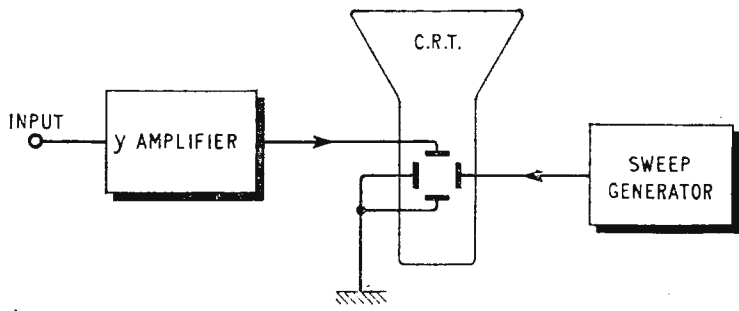

Fig. 1. Basic functions of general purpose oscilloscope.

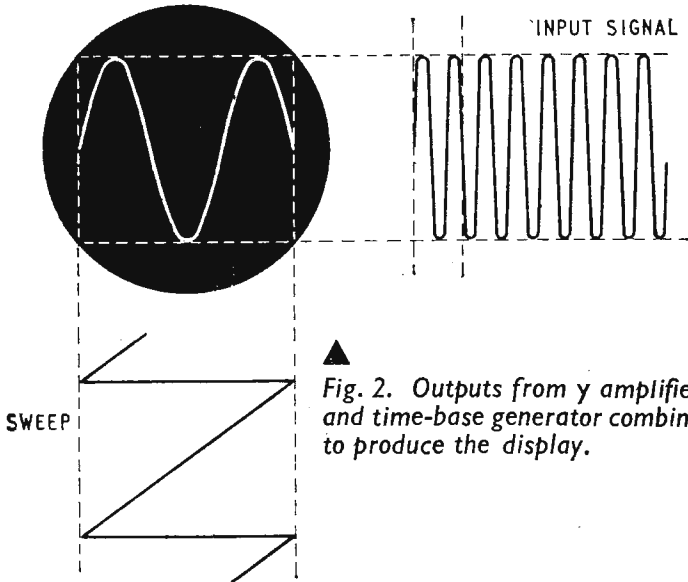

Fig. 2. Outputs from y amplifier and time-base generator combine to produce the display.

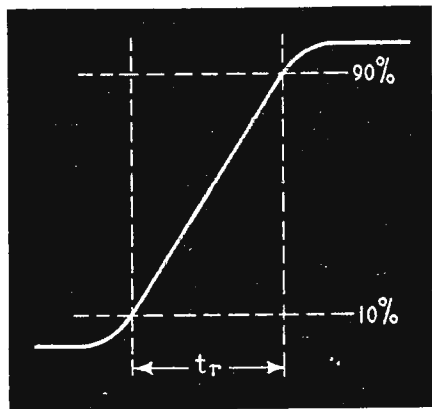

Fig. 5. Method of specifying rise-time.

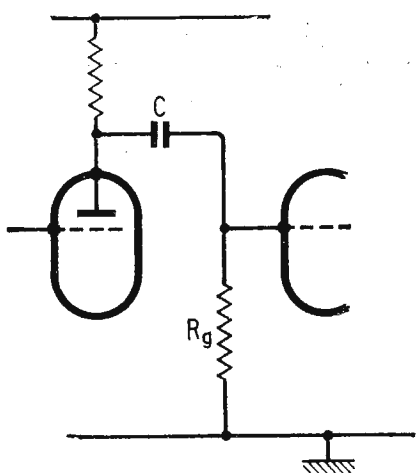

Fig. 8. A.-c. coupling.

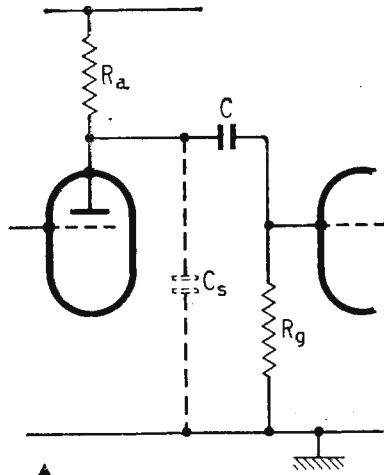

Fig. 3. Stray capacitance is disposed in parallel with the load resistors, assuming the impedance of the power supply is negligible.

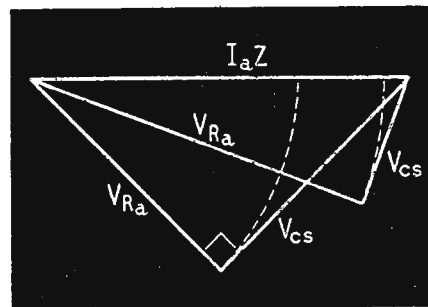
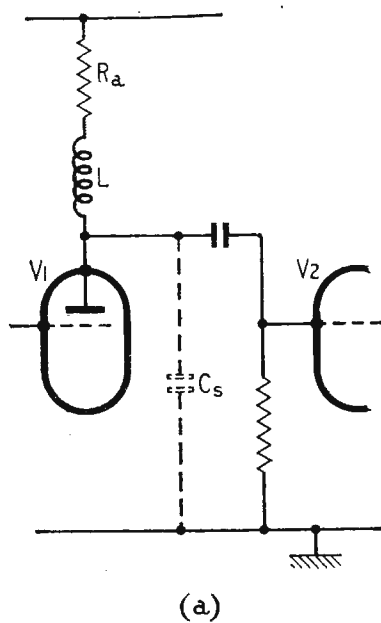
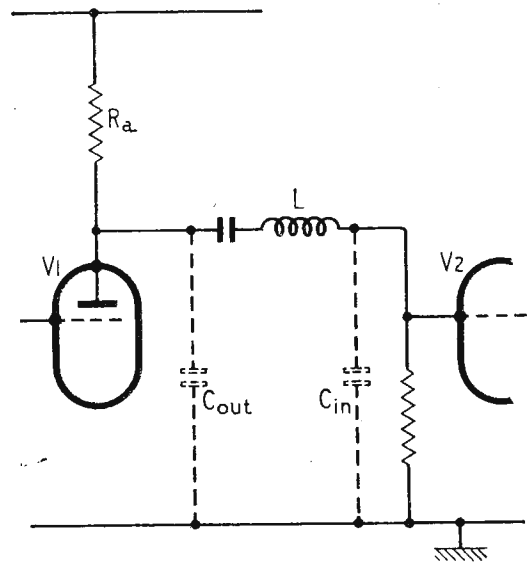

Fig. 4. At l.f., anode signal voltage is effectively developed across  $R_a$  alone and is  $I_a Z$ . At h.f.,  $C_s$  becomes comparable with  $R_a$ .



(a)



(b)

Fig. 6. Shunt (a) and series (b) h.f. compensation.

Fig. 7. Effect of carrying high-frequency compensation too far.

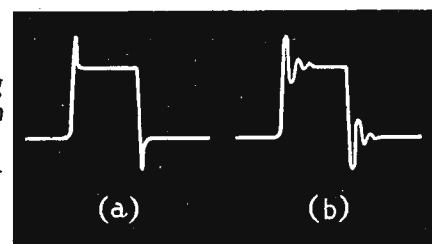

(a)

(b)



fier exist, and it is partly for this reason that both y amplifier and timebase generator have, in the *Wireless World* design in common with many others, been made replaceable, plug-in units. The two functions can therefore be suited to a particular purpose and made as simple or as elaborate as required, and a whole series of units will be described from time to time.

A fairly common order of sensitivity is 50mV/cm. This means that 50mV applied to the input will be sufficient to deflect the spot one centimetre. C.r.t.'s need between 10 and 50V for this deflection, so that the amplifier gain required is between 200 and 1,000. This may not seem an outstanding amount of amplification, until it is realized that it must be the same at all frequencies from a few cycles per second to upwards of 10 Mc/s. A response extending to zero frequency is also found very useful at times. Amplifiers exist which will handle frequencies up to 2,000 Mc/s, but these do not bear much relation to the kind we shall be concerned with, and they use entirely different techniques. The ordinary RC-coupled voltage amplifier works fairly happily up to about 50 Mc/s, with a bit of trickery, but above this frequency, different methods are employed which use more valves, are difficult and expensive, and will be left severely alone.

**H.f. Compensation:** The biggest single headache in high-frequency amplifier design is capacitance, both intended and accidental. It curtails both ends of the frequency-response characteristic and is to be avoided as much as possible. In Fig. 3,  $C_s$  represents the total stray capacitance from the anode of one stage of the amplifier to earth. This total takes in the internal capacitance of the valve, the capacitance of the valveholder, the strays of the wiring, and the input capacitance of the next valve or load, and probably amounts to between 15pF and 25pF. The gain from the stage is  $g_m Z$ , where  $Z$  is the impedance of the  $R_a$  and  $C_s$  combination, and at low frequencies this is simply  $g_m R_a$ . As the signal frequency increases, the reactance of  $C_s$ , which is  $1/2\pi f C_s$ , begins to become comparable with the resistance  $R_a$ , and as  $C_s$  is effectively in parallel with  $R_a$ ,  $g_m Z$  decreases. At the point where  $1/2\pi f C_s = R_a$ , the gain is only 70% of that at low frequencies, as is shown by Fig. 4. This point is the one most often quoted as defining the bandwidth of the amplifier, and as a decrease in gain of 30% is also approximately -3dB, it is known as the 3dB point. With an  $R_a$  of 10k $\Omega$  and stray capacitance of 20pF, the gain of a valve with  $g_m = 5$  will decrease from 50 at low frequencies to 35 at 800 kc/s.

It may not be entirely clear why so much importance is placed on the reproduction of high frequencies, and a digression is therefore needed. Any waveform can be made up by a combination of many frequencies and amplitudes of harmonically related sine waves, and the faster a voltage changes from one value to another, the higher the component frequencies. Frequency response and the time taken for a voltage to change are roughly related by the expression  $ft_r = 0.4$ , where  $f$  is the -3dB point in Mc/s and  $t_r$  is the "rise-time" in  $\mu$ sec of the waveform shown in Fig. 5. The time is measured between 10% and 90% of the total voltage change. For instance, for a rise-time of 0.1 $\mu$ sec—not a particularly fast step—the amplifier bandwidth needed is  $0.4/0.1 = 4$  Mc/s. In

the present U.K. television transmissions, the video channel contains frequencies up to 3 Mc/s while the 625-line transmissions will have a component of 6 Mc/s. To examine waveforms containing a 6 Mc/s component, the oscilloscope must have a much wider bandwidth, and 10 Mc/s is a reasonable compromise between precision and cost.

To return to our amplifier, there are several methods of postponing the effect of stray capacitance, two being indicated in Fig. 6. The operation of both depends on the use of inductance to compensate for the stray C and the circuits shown in Figs. 6(a) and 6(b) are known as shunt and series compensators respectively. In Fig. 6(a), the reactance of  $L—2\pi f L—$  is made to balance that of  $C_s$ , and as  $X_{C_s}$  falls,  $X_L$  rises and tends to keep  $g_m Z$  constant. This process can only be effective over a limited range of frequencies, and if  $L$  is made too large,  $L$  and  $C_s$ , which form a parallel-tuned circuit, turn the circuit into a tuned amplifier and the result is a peak in the frequency response curve. If the signal has fast step, the display will take the form of Fig. 7, where the rise is continued into an overshoot, and if the effect is very bad, a train of damped oscillations—a ring—will follow each rise or fall. The circuit shown in Fig. 6(b) uses  $L$  to separate the components of  $C_s$ , which are the output capacitance of V1 and the input capacitance of V2. The same remarks apply as to Fig. 6(a), but the improvement in frequency response is better. Both these circuits will be discussed more precisely and in more detail when the practical amplifiers are described. For audio and most broadcast radio work, a simple RC-coupled amplifier is sufficient.

**L.f. Compensation:** At the low-frequency end of the characteristic we are once more in trouble with capacitance, but this time the problem is to get enough. The coupling capacitor  $C_c$  in Fig. 8, forms a potential divider with  $R_g$  as the bottom arm, and at the frequency where the reactance of  $C—1/2\pi f C—$  is equal to  $R_g$ , we are once again 30% down or -3dB. Taking the average value of grid resistor as 470k $\Omega$ , a 0.1 $\mu$ F capacitor will give this amount of reactance at 3.4c/s. From the point of view of waveforms, a square wave passing through an RC-coupled amplifier takes the form of Fig. 9 and looks more or less weary, depending on the product  $CR_g$ . The sag from A to B is roughly calculated from the expression  $t/CR_g$  where  $t$  is the time from A to B, or half a cycle. For the components assumed, a 50c/s square wave would sag by 20%, and each successive stage makes matters worse. Clearly, some form of compensation is needed, one method being shown in Fig. 10. At high frequencies,  $R_1$  is effectively short-circuited to the signal by  $C_1$  but at low frequencies the anode load becomes  $R_2$  in series with  $C_1$  and  $R_1$  in parallel, and the gain remains constant to a much lower frequency. For best results,  $C_1 R_1 = C_2 R_2$ . Several other circuits are used, and will be discussed in the appropriate article.

A response extending to zero frequency or, as the specification writers have it, d.c., is useful in several respects, and the difficulty of obtaining a stable amplifier is often worth while. The chief trouble is the tendency of directly-coupled amplifiers to change their characteristics slowly with variations in temperature, h.t. and l.t. voltages. Many are the circuit configurations that have been employed to reduce this trouble, but modern amplifiers follow a fairly

standard pattern. Z.f. amplifiers are mainly used for pulse and waveform techniques, where it is required to know the d.c. level of an a.c. signal. Perhaps this is better described by a diagram, and Fig. 11 is the relevant one. The circuit is a familiar one, the Miller transitron, the electrode voltages being shown at (a) and (b). With a directly-coupled amplifier, the waveforms are displayed in the correct position in relation to h.t. and earth, while in the a.c.-coupled position, they are symmetrically disposed about the zero line. That this can be very convenient is clear, and most modern laboratory instruments possess z.f. amplifiers.

**Measurement:** As has already been mentioned, the engineer needs information not only on the shape of a signal, but also on the amplitude and time. Three methods of voltage measurement are in common use, all having their pro's and con's and all used in precision equipment. The first type of calibration used is still a perfectly good system and is used in the No. 1 amplifier in the "W.W." instrument. It consists of a known voltage, usually a sine or square wave, applied to the input of the amplifier. The voltage is adjusted by a calibrated control until it occupies the same amount of the c.r.t. screen as the signal, and the voltage read off the scale. A second method relies to a greater extent on the gain stability of the amplifier in that, at each setting of the input attenuator, the sensitivity is set at a given number of divisions on the screen graticule. Any adjustment of the gain control invalidates the measurement, but it is always possible to obtain a conveniently-sized display if the attenuator steps are correctly chosen. The third method is only possible with directly-coupled differential amplifiers. A direct voltage equal to the signal amplitude is applied to the second grid of a long-tailed pair amplifier, the deflection reduced to zero and the amount of direct voltage needed to do this read from the scale of a calibrated potentiometer.

The No. 1 amplifier to be described is essentially a low-frequency design, suitable for audio and radio work, and consists of an a.c.-coupled pentode stage followed by a long-tailed pair phase-splitter to feed the c.r.t. deflection plates. Calibration is of the type shown in Fig. 12(a). It was not felt that in this first unit, any purpose would be served by using direct-coupling with its inevitable extra cost, and signal-injection calibration is rather cheaper to provide than the alternatives, with the advantage that calibration holds with adjustment of the gain control.

So much for the y deflection system. More detailed descriptions will follow when the designs themselves are presented. We must now concern ourselves with the x, or horizontal spot-deflection units, and will start with the time-base generator.

### Sweep Generator

Timebase, or sweep-producing circuits are probably responsible for more reputations, of both kinds, than any other single branch of electronics, with the possible exception of sine-wave oscillators. This is all the more strange because every last one of them depends on the same effect—the slow charge or discharge of a capacitor through a resistor, and a rapid recovery. As can be seen from Fig. 2, the voltage waveform required to give the constant-speed scan of the spot across the c.r.t. screen and a rapid "flyback" turns out to be a triangular shape,

or sawtooth. Circuits for producing this shape of wave are many, varying from the simple, highly-curved, free-running devices to the high-precision, triggered generators used in laboratory instruments. The basic principle of them all is shown in Fig. 13, and the No. 1 unit for our oscilloscope uses a modified version. Capacitor C charges up exponentially through R, and when the voltage across it reaches the point at which the discharger, D, comes into operation, the capacitor discharges through it rapidly, the resistance of the discharge circuit being much smaller than R. The sawtooth wave is produced across the capacitor C and the frequency can be varied by adjustment of C or R. Refinements of this circuit are mainly concerned with improvements to the discharger and with attempts to make the voltage rise during the charge period more nearly linear. D can take many forms, the simplest being a gas tube, which approximates to a diode filled with an inert gas such as neon; a voltage across the electrodes ionizes the gas and provides a low-resistance path. The point at which the gas ionizes is 20 to 30 volts higher than the voltage at which the tube extinguished, and the sawtooth is of this amplitude. It is usually required that a pulse is obtained from the sweep generator during the flyback period which can be used to suppress the c.r.t. spot at this time and avoid the confusion of two traces going in opposite directions. A circuit which provides this is shown in Fig. 14. The discharge circuit is formed by two triodes connected in the Schmitt trigger configuration, which, as far as the charging circuit CR is concerned, is the same as a gas tube. During the flyback however, pulses are produced at the two anodes which can be applied to the cathode or grid of the c.r.t. to suppress the spot. This is the form of timebase we shall use in the first unit and it will be described in greater detail in a future article.

**Linearity:** Perhaps a short discussion of some of the principles of linearization would not be out of place, as we shall make use of some of them at a later stage. The basic fact to get clear is that to obtain a perfectly linear change of voltage across a capacitor, the current flowing into it must be constant. No means have yet been found of conforming to this ideal completely, but some methods produce a sweep which does not measurably depart from linearity. The type of generator described so far relies on a high-value resistor to approximate to a constant-current source, and unless only a small part of the charging curve is used, the curvature is intolerable. A better (and more expensive) method is to make use of the fact that, above about 50V, a pentode presents a very high a.c. impedance, which is seen from a glance at the  $I_a - V_a$  curves; a large change of  $V_a$  makes almost no difference to the anode current. If, therefore, a pentode is used as a charging resistor, the rise in voltage is almost linear.

**Miller Transitron:** The most common principle used in modern timebase generators is the use of a feedback amplifier to linearize the voltage sweep. Fig. 15 shows the general arrangement. As the voltage across the capacitor increases, the voltage across R falls, and this fall is amplified. The output voltage of the amplifier increases and is fed in series with the CR circuit to keep the charging current constant. A practical circuit is shown in Fig. 11 and is known as the Miller transitron, the circuit

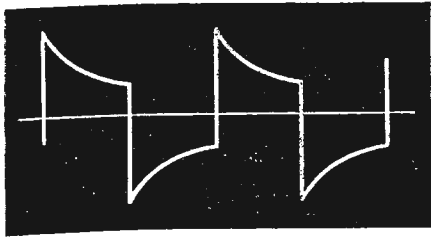
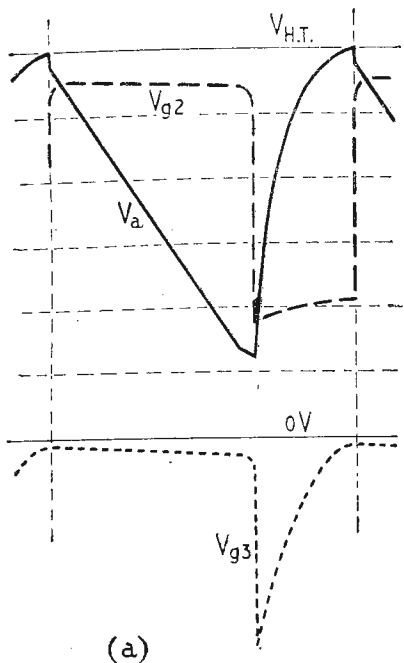

Fig. 9. An attenuated l.f. response distorts a square wave in this manner.



(a)

Fig. 11. A direct-coupled amplifier produces a display as in (a), while a.c. coupling (b) gives no information on level.

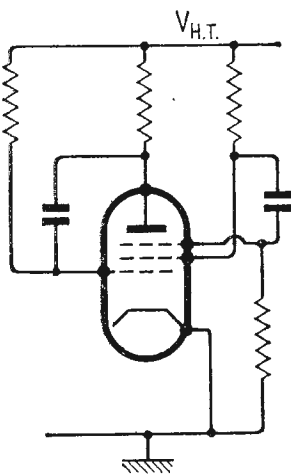
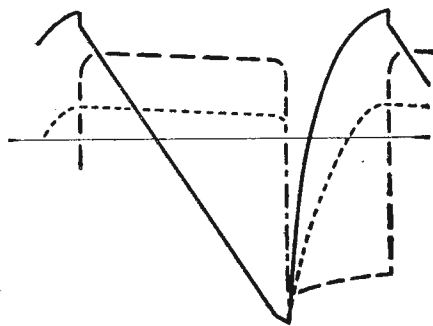
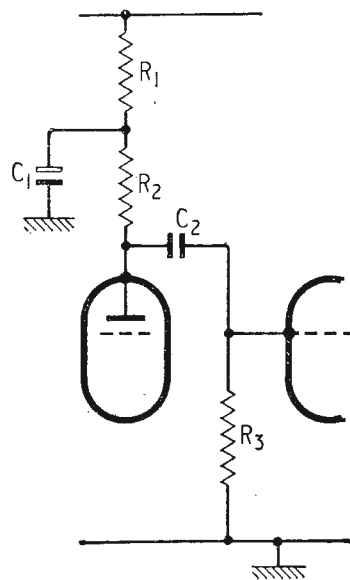
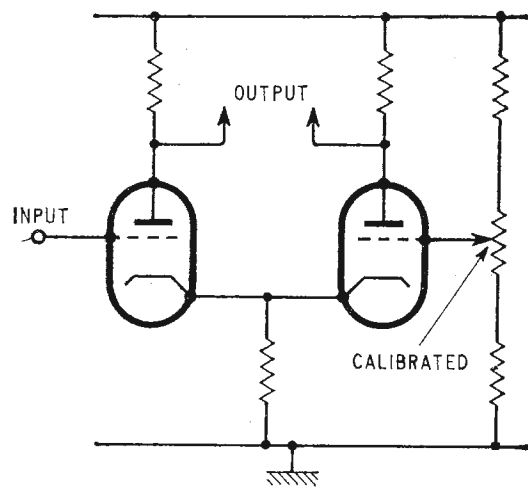

Fig. 10. L.f. compensation components,  $C_1$  and  $R_1$ .



(b)



(b)

Fig. 12. The two calibration systems we shall use.

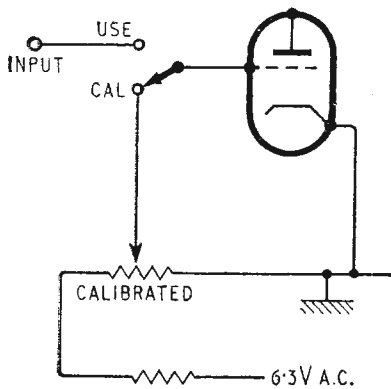

(a)

Fig. 13. Basic sawtooth or triangular-wave generator.

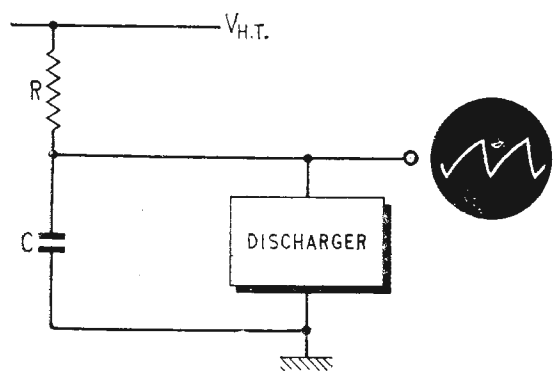
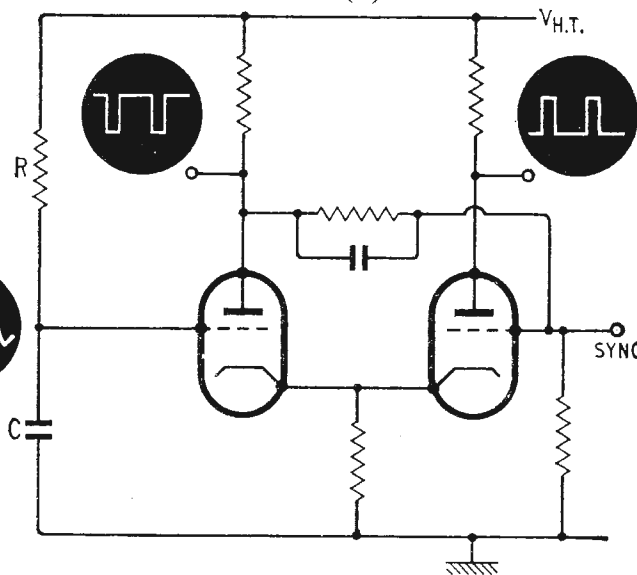

Fig. 14. Schmitt trigger sweep generator giving pulse outputs for fly-back blanking.



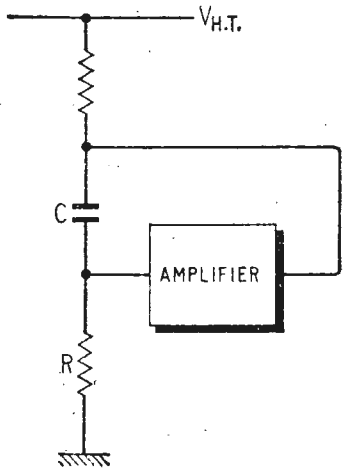

Fig. 15. Principle of feedback - amplifier linearization.

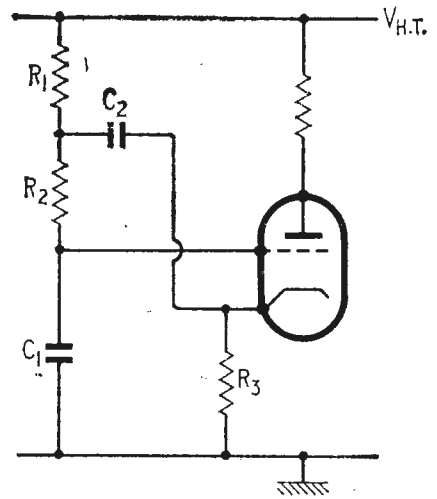

Fig. 16. Bootstrap linearizer.

Fig. 17. In cases (a) and (c) the sweep is not synchronized, while (b) and (d) give a single, synchronized picture. In triggered condition, (c) and (d), sweep is always synchronized if trigger pulse is obtained from y amplifier.

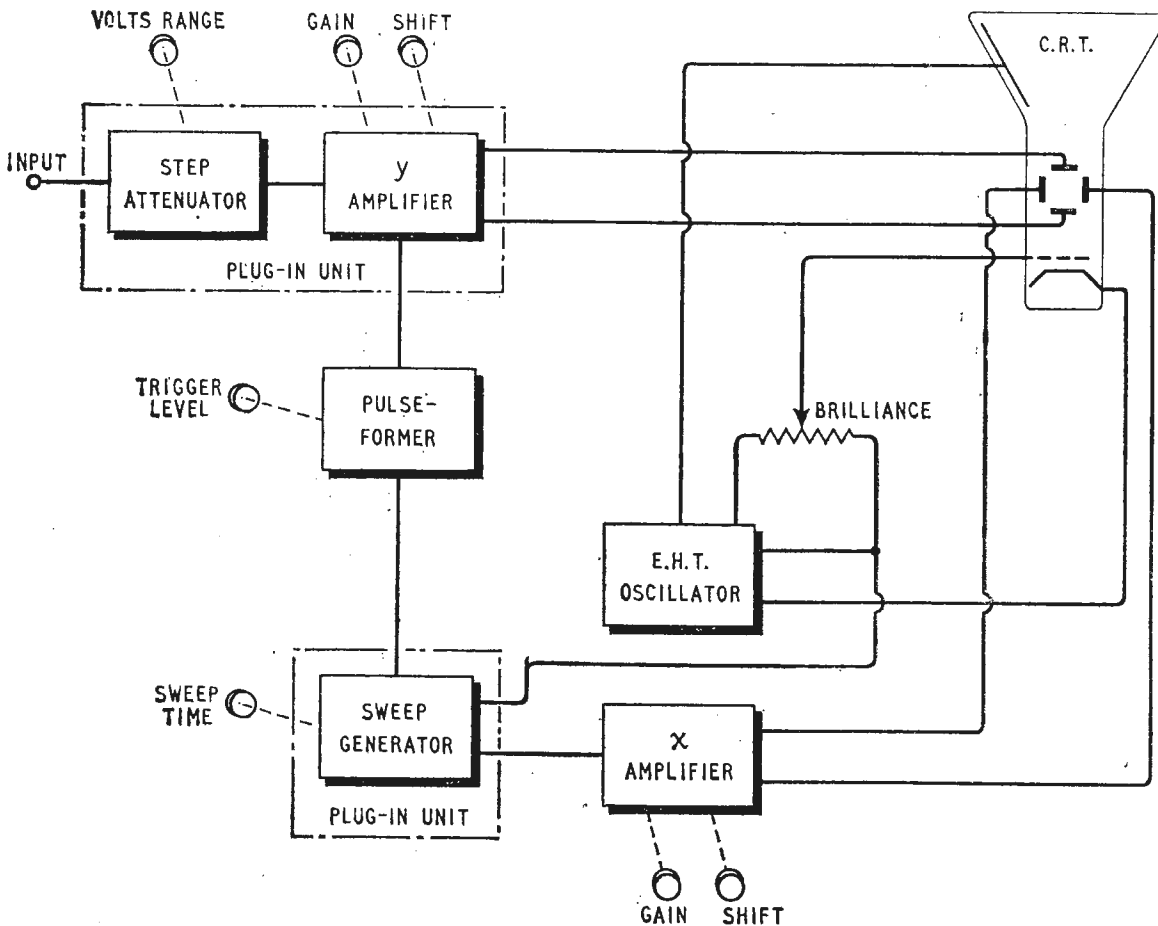
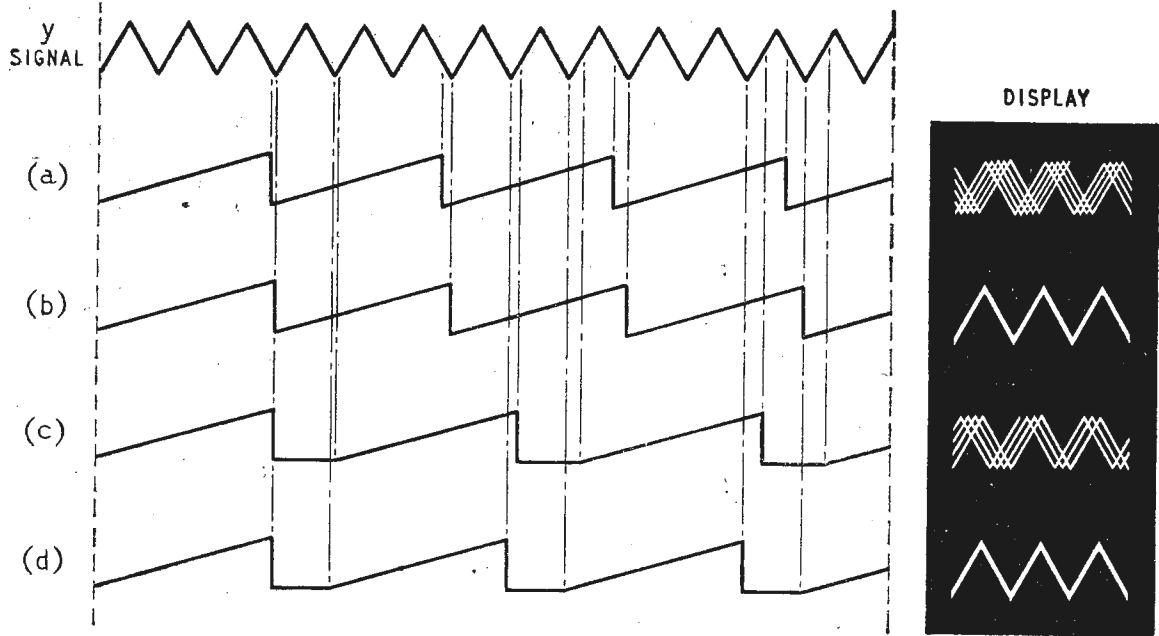

Fig. 18. Block diagram of complete oscilloscope, showing main controls. Main power supply is not included.

also performing the function of a discharger. C and R in Fig. 14 correspond to C and R in Fig. 11. If the gain of the amplifier is high, it can be assumed that the grid voltage remains almost constant for a large charge in anode voltage, and if the grid voltage stays put, so must the current in R. The capacitor discharges through R with, therefore, constant current and, as we have seen, this gives a linear change. The linear fall in anode voltage continues until the voltage is so low that the screen becomes a serious competitor and begins to take more than its normal share of cathode current. The screen voltage falls, and the change is fed to the suppressor grid via  $C_2 R_2$ , a differentiating circuit. The suppressor being driven negative, anode current is decreased, more cathode current goes to the screen, the fall in screen voltage is passed to the suppressor . . . and so on. The action is a rapid switching sequence and the result is a complete absence of anode current, heavy screen current and a suppressor voltage which is returning to its "cut on" value in a time governed by the product  $C_2 R_2$ . The anode voltage returns to  $V_{ht}$  in a time  $C_1 R_1$  and the whole thing starts again. We therefore have a linear, repetitive sweep, the frequency of which is governed by the value of  $C_1$ ,  $R_1$  and the voltage to which  $R_1$  is returned.

**Bootstrap:** A similar principle is employed in the "bootstrap" circuit shown in Fig. 16. This is also a feedback amplifier and, in fact, is almost identical, basically, to the Miller circuit. In this case, the capacitor  $C_1$  changes towards  $V_{ht}$  through  $R_2$  and the signal across  $C_1$  is applied to the cathode follower. The output across  $R_3$  is fed to the "top" of  $R_2$ , so that the "aiming" voltage of  $C_1$  increases as the charge increases, tending to keep the current constant, and "pulling itself up by its own bootstraps." The circuit needs a separate discharger.

Refinements and combinations of these two circuits are responsible for the vast majority of oscilloscope timebases, variations being occasioned by the need for synchronizing and triggering by the  $y$  signal and external sources, and the difficulties of high-speed operation.

**Synchronizing:** The time the spot takes to complete one sweep across the c.r.t. must be variable to avoid a confusing jumble of traces. Fig. 17 shows what is meant by this. At (a) the time base does not take an integral number of cycles of the  $y$  signal to get across the screen, and therefore does not start at the same point on the  $y$  signal at each sweep. At (b) this does happen, and the timebase is said to be synchronized. This state of affairs can also be brought about by keeping the sweep speed constant and varying its repetition rate, as in (c) and (d). This method is used for triggered timebases (i.e., types that require a pulse to produce each sweep) and has the advantage that as the speed is constant, calibration is made much simpler. We will be using a timebase of this type in one of our later units. Sync and trigger pulses in our instrument, are obtained from the  $y$  signal by means of a Schmitt pulse forming stage. Either internal or external signals, positive—or negative—going, can be used, with a variable level control to adjust the point on the  $y$  waveform at which the sweep starts.

**Time Measurement:** As in voltage calibration, several equally good methods of time determination are in common use, and we will use at least two of them in our timebases. Possibly the most accurate

way of calibrating the timebase is to impress upon it a series of time markers, either as vertical deflections from the  $y$  amplifier or as bright or dark spots by means of intensity-modulating the c.r.t. itself. This method never seems to catch on to any marked extent, although the Cossor 1076 60Mc/s oscilloscope uses it successfully. The modulating signal is often obtained by exciting a high-Q tuned circuit, or even a crystal, by means of a pulse or step from the sweep generator, and applying the train of oscillations to the grid of the c.r.t. A continuous-wave oscillator cannot be used, because the modulating signal must be phase-related to the sweep so that the spots come in the same place every time. Other methods depend on the linearity and constancy of amplitude of the sweep voltage and/or the  $x$  amplifier. For instance, the Marconi TF1330 series which uses the type of sweep in Fig. 17(c) and (d) the sweep amplitude is inherently constant, as is the sweep time for a given range, so that, assuming linearity of sweep, the relationship between sweep voltage and time is constant. The calibration can then take the form of a calibrated shift control at the input to the  $x$  amplifier, with the advantage that calibration holds for any gain adjustment of the amplifier, and even if it is not linear. A third method of measurement is to calibrate the sweep time control in time per division of the c.r.t. graticule. This is more inconvenient than the others in that it can involve a certain amount of mental arithmetic, but it is simple to provide, and was considered suitable for our first unit.

### Power Supplies

The stability and measurement accuracy of an instrument is dependent to a large extent on the constancy of its power supplies, and in the "W.W." oscilloscope, both positive and negative supplies are stabilized. The extra high tension (e.h.t.) supplies for the c.r.t. are derived from an oscillator. This has the twin advantages that the ripple frequency is much higher, and therefore easier to smooth, and that the output impedance is very high, which means that if one touches the output rail accidentally, no damage to either life or limb is caused. With "Battersea power station on the other end" in a mains-derived supply, one cannot be quite so light-hearted about three or four thousand volts. The blanking pulse is applied to the c.r.t. grid via a "floating" winding on the e.h.t. transformer, so avoiding the necessity for a blocking capacitor, with its inevitable differentiation.

### Cathode-Ray Tube

The tube we have used is the Mullard DN7-78 3-in flat faced instrument tube which has a post-deflection acceleration ring operated at 3kV. The negative e.h.t. required is of the order of 750V. Deflection sensitivity in the  $y$  direction is 9 volts per centimetre at 750V cathode voltage, which makes amplifier design relatively simple.

### Applications

Having built the oscilloscope, the uses to which it can be put may not appear entirely obvious, and a further article on this subject is necessary. This will appear after the constructional details have been given, and will describe the operation of the instrument in the testing of audio and radio equipment, and television receivers.

# "AEROSPACE" TELEMETRY—a short review

IT is generally accepted that the task facing the designer of "aerospace" telemetry is much more formidable than that encountered with other comparable communication systems. Not only has he to endeavour to produce an utterly reliable system meeting definite standards of accuracy but also this has to be achieved within severe design "constraints," particularly the environmental and other limitations imposed by the rocket or satellite concerned. In relation to these conditions there are three major areas in which improvements in system performance can be sought. The first two of these divisions are associated with the space vehicle itself, and are the bandwidth (fixed basically by the "amount" of measurement intelligence required to be transmitted), and the effective radiated power from the vehicle. The third division embraces the ground receiving installation in terms of its efficiency compounded from the "goodness" of the aerial as a collector of radio energy, and the overall noise figure of the receiving system, usually expressed as an equivalent noise temperature.

With the intensive research and development programmes being undertaken in this field at the present time, demands tend to grow at an ever-increasing rate for more telemetry data channels, each with a wider frequency response. To meet this demand means that the signal bandwidth becomes greater, i.e., that the signal/noise ratio of the whole telemetry link is degraded because of the proportional increase in noise with bandwidth. Clearly, if accepted, this change in the fundamental system parameters must be offset by an improvement in signal/noise ratio obtained elsewhere. It will be realized that little can be done with regard to effective radiated power—the power supplied to the transmitter is strictly limited by the permissible weight and the volume available for its source, while vehicle aerial systems cannot be given high efficiency as radiators (e.g., they must be made isotropic rather than directional and must be kept physically small).

In these circumstances it becomes necessary to concentrate largely on the ground receiving equipment. Improvement in signal input to the receiver can be achieved by increasing the "aperture" of the aerial and with it directivity and hence its gain. A price must be paid for this increased gain in that relatively complex aerial "steering" equipment must be provided to follow the moving transmitter. The other major factor, noise, can be reduced by introducing new techniques such as parametric amplification in the first stage of the receiver, but again complication, and consequently expense, is entailed.

At a recent I.E.E. conference on Satellite Communication it became evident that the trends outlined above were being followed closely both in the satellite telemetry systems themselves and in the corresponding "service" communication links. As an outstanding example of this common ground, it was clear that these communication links had been designed on the basis of the maximum return being obtainable from the ground receiving equipment. Thus at the British station at Goonhilly Downs, Cornwall, and at the U.S. station at Andover, Maine, extremely large aerials with precision steering systems have been installed, together with special low-noise amplifiers in the first stages of the

receivers. The two reflector apertures are 5,700 sq ft and 3,600 sq ft for Goonhilly and Andover respectively, but it appears that the lower aerial gain implied for the latter is counterbalanced by a rather better overall receiving system noise performance.

At this point it should be noted that the operating frequency, 4,170 Mc/s, for the communication link is more than an order up on the 136 Mc/s allocated for the telemetry senders used in the Telstar and Relay satellites. However, it can be taken for radio telemetry as a whole that a move to much higher frequencies must be regarded as inevitable. A number of factors contribute to this result, of which one is the availability of frequencies as determined by international agreement, another is the tendency already mentioned, for signal bandwidths to increase and thus to necessitate a corresponding increase in carrier frequency. Consequently it is a reasonable assumption that the techniques developed for the higher frequencies will find application in the telemetry field in the not too distant future.

In this connection the following points should be made with regard to the difference between the rocket and the satellite applications. This difference is probably greatest for the paths followed by the two types of vehicle and consequently for the tracking methods which can be adopted in each case. Thus the orbit of the satellite is completely predictable for each "pass"; whereas, although a rocket is fired on a planned trajectory, it cannot be expected to follow an exact velocity programme because of variations in motor specific impulse, etc., between individual missiles. It is therefore common practice for satellite tracking to be carried out under the control of a digitally coded tape which has been prepared from predicted orbital data. Such data is made available on a world-wide basis for Telstar by the Goddard Space Flight Center, Greenbelt, Maryland. Provision is usually made for auto-following in the satellite case, but even if it is used the "putting-on" problem is rendered extremely small by prediction. On the other hand, it will be realized that the acquisition of a missile is much more difficult, and it may be that two aerial systems will have to be used at the higher frequencies—a "coarse" one for short range working, and a narrow beam "fine" one to take over in the auto-follow mode for the longer ranges. Furthermore, it may well be that the complexity of the liquid-helium-cooled travelling-wave maser amplifiers in particular, employed at both Goonhilly and Andover, will rule them out for use at "up-range" receiving stations for rockets. This may also be the case at base stations purely for economic reasons.

Finally it is of interest to note that pulse code modulation is used in both the Telstar and Relay telemetry systems. There is a difference between them, however, with regard to the two-stage modulation method which is almost invariably adopted for such systems. Thus for Telstar the modulation sequence is f.m.-p.c.m., while for Relay it is p.c.m.-p.m.

A further point of interest is that the frequency modulation in the Telstar scheme takes place as an a.c. frequency change of 3 kc/s; and that this increment produces the alternation between the equivalents of "0" and "1" or "off" and "on" in the modulated, and hence coded, waveform.

R. E. Y.



# NEW MARCONI 'SOLID STATE' AUTOPLEX

The most advanced error correcting telegraph equipment in existence

## ERROR PROOF HF TRAFFIC

**WITH** 40% less capital cost per channel  
75% reduction in size  
75% reduction in weight  
90% reduction in power consumption

**PLUS** Considerable savings in manpower, spares and maintenance

- \* One cabinet houses equipment for two 2-channel circuits which may be operated as one 4-channel circuit
- \* Modular construction means greater reliability and greatly simplified maintenance
- \* Built-in character storage for 4 or 8 character repetition cycle
- \* Fully automatic phasing including rephasing in traffic with no loss or duplication of characters
- \* Average rephasing time in traffic 4 seconds
- \* Mis-routing of sub-channels is impossible even with sub-division on all channels
- \* Error rate improvement factor of 100-10,000

\* **FERRITRANSISTORIZED** code converters and stores surpass fully transistorized designs by significant reduction in power and saving in space.

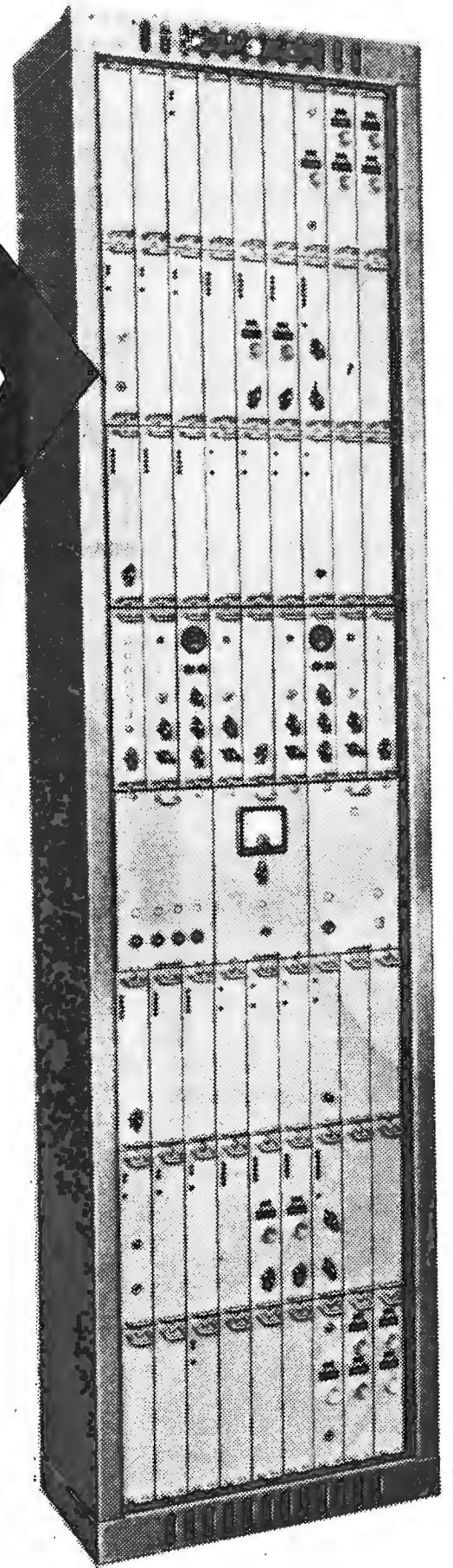

# MARCONI SOLID STATE AUTOPLEX

accurate ERROR CORRECTION MULTIPLEX TELEGRAPH SYSTEMS

MARCONI'S WIRELESS TELEGRAPH COMPANY LIMITED · CHELMSFORD · ESSEX · ENGLAND

Perhaps you have not thought of glass for that new component. But we have had so many inquiries recently from engineering designers who see in glass the necessary electrical, thermal and abrasion-resistant qualities (whether or not transparency is needed) that we have set up a new division at Chance-Pilkington Optical Works. This will give a complete service in developing and manufacturing industrial glass pressings, to the high standards for which Chance-Pilkington glass is already world famous in the optical and ophthalmic fields. Have you a problem component? If so, telephone St. Asaph 3281, and tell Ken Appleton about it. We'll have things moving quickly. (Chance-Pilkington are internationally renowned for speed and service as well as for precision and quality).

**WHEN TRADITIONAL  
MATERIALS  
DON'T MEASURE UP**

*Take a  
look at*

**GLASS**

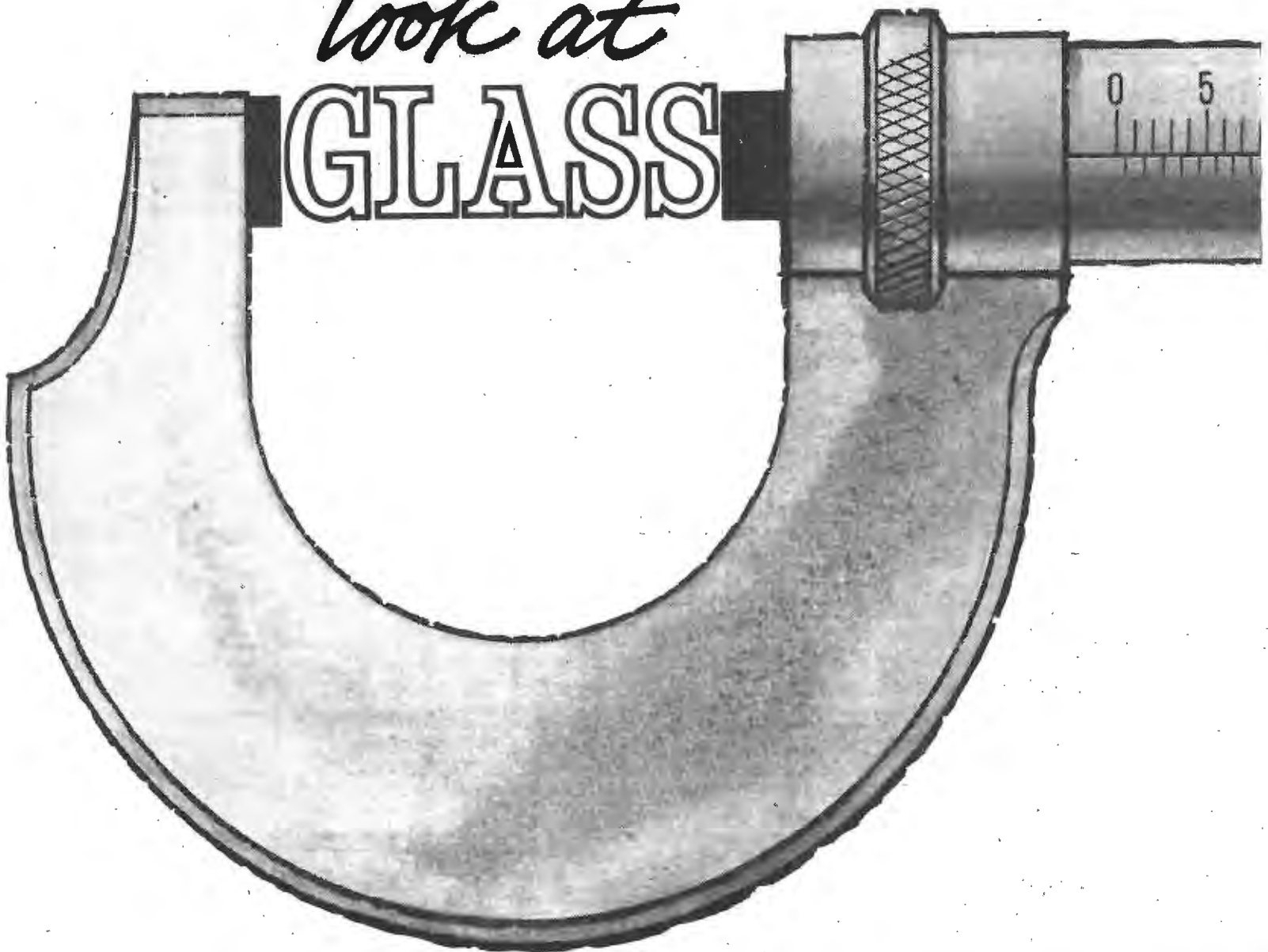

**CHANCE-PILKINGTON  
OPTICAL WORKS**

**St. Asaph, Flintshire**

*One of the great Pilkington glassmaking companies*

Please send details of the Chance-Pilkington Industrial Glass Pressings service to

NAME .....

ADDRESS .....

W.W.I.

# PHYSICAL SOCIETY EXHIBITION 1963

Heralded by cold winds and frozen roads, the 1963 Institute of Physics and Physical Society Exhibition opened in the Horticultural Halls, Westminster. Restrictions on the number of exhibits per stand and the provision of wider passage ways eased to a certain extent movement in the halls. Afternoon visitors, however, were still too numerous for comfort and ease of inspection of the exhibits.

Prominent among the exhibits were test and measuring instruments, medical developments, industrial control and components. Worthy of especial mention were the entries in the Craftsmanship competition in scientific instruments and apparatus. The items on show in the vestibule of the New Hall more than justified their prominent position.

## TEST AND MEASUREMENT

A tracer for valve and transistor characteristics with several interesting features has been developed for the use of staff and students in the electronic laboratories of the Royal Military College of Science. The equipment enables the display of a single characteristic curve or a family of four such curves. Using the conventional form of display these can be calibrated enabling quantitative information to be obtained. In the case of valves,  $r_a$  and  $gm$  and in the case of transistors, slope resistance and " $\beta$ " are easily derived. Up to seven transistors may be attached to the tracer and the display switched from one to the other enabling rapid comparison of characteristics. The voltage and current markers are calibrated by comparison with a "set-in" d.c. supply which is measured on a meter. Tetrode and pentode valves can have suitable potentials applied to their second and third grids, the potential being measured on the same meter. Two cathode ray tubes, one for direct viewing and the other for photographic purposes, are present on the equipment. By making several exposures on the same plate curves of one valve under various conditions or different valves or transistors may be superimposed on the same photograph. The mains supply at 50c/s operates a squarer stage followed by two binary stages providing eight time intervals in one period of 80 milliseconds or a p.r.f.

of  $12\frac{1}{2}$ c/s. Four of these intervals are used to display the characteristic curves and the other four the axes and markers. The squarer and binary stages are also used to initiate the negative step generator which supplies negative known amplitude steps to the valve or transistor base. All the "X" information is applied to a combining circuit, the "Y" information is applied to another combining circuit. The output of these circuits is applied to the display amplifiers which have push-pull outputs for the deflecting plates and provide expansion and shift of the display without disturbing the calibration. Each circuit function is mounted on a separate panel. The supplies are taken to each unit by means of a flexible lead and 6-pole plug, the signals by single coloured leads and single-pole plugs. This arrangement enables signal paths to be easily traced, functioning of the units checked and modifications to be carried out.

The dearth of pulse generators at the 1962 exhibition was more than made up for by the introduction of three new ones at this year's show.

An extremely flexible and fully transistorized pulse generator was shown on the Venner Electronics Ltd. stand. Normal controls associated with pulse generators such as frequency, pulse width, delay of pre-pulse, etc., are supplemented by controls for carrying the rise and fall

Royal Military College of Science valve and transistor characteristic tracer.

times of the leading and trailing edges. Amplitude controls, d.c. level control and polarity reverse switches are included. The maximum pulse amplitude is ten volts and the output impedance is approximately 50 ohms.

Versatility still being the keyword the pulse generator Type PG 53 introduced by Nagard makes use of plug-in units. Basically the generator consists of power supplies and four units. Of these, one is the trigger source unit; the other three are delayed pulse generators. The trigger source unit initiates pulses produced by the delayed pulse generators. This unit may also be used as a square-wave generator. It can be triggered externally by any type of signal and polarity from 0 to 25 Mc/s (20 mV r.m.s. sine-wave, 10mV P-P pulse), the triggering level being adjustable. Internally, triggering is controlled by a rate generator or clock in three modes; normal mode—100 ms to 100 ns continuously variable and calibrated; synchronized mode—synchronizes without adjustment to sine-wave input of less than 2V from 5c/s to 50 Mc/s; gated mode—positive 2V pulses causes clock to run for period of pulse. A square-wave output is available at the clock frequency (10c/s-10Mc/s) continuously variable and calibrated,

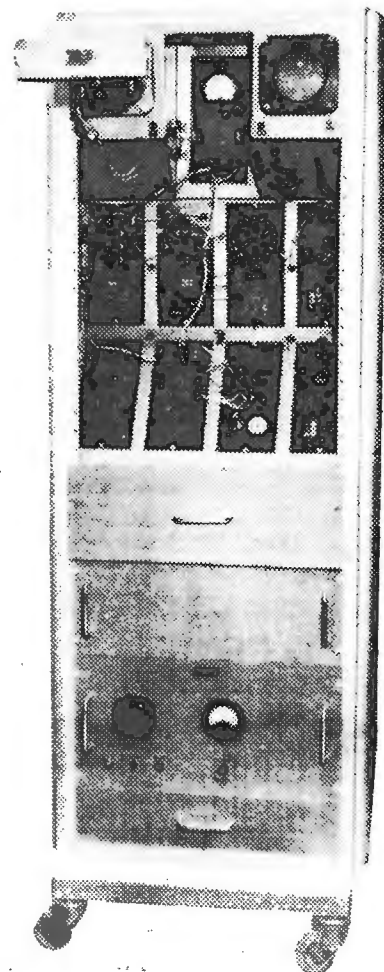

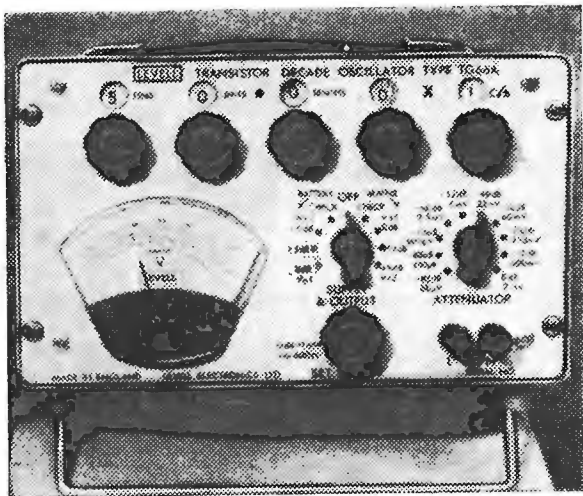

Levell Electronics oscillator Type TG66 A.

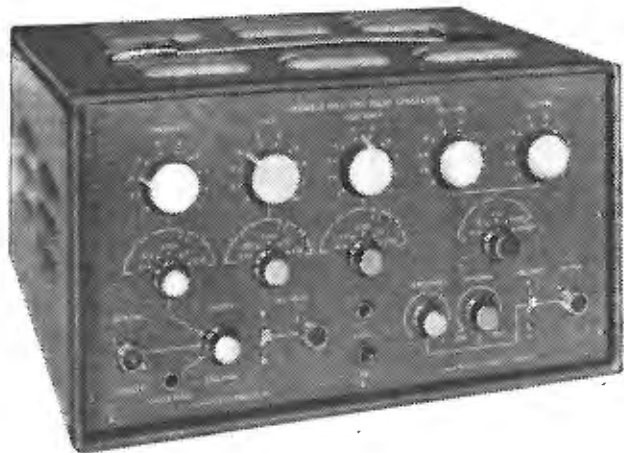

Venner variable rise-time pulse generator.

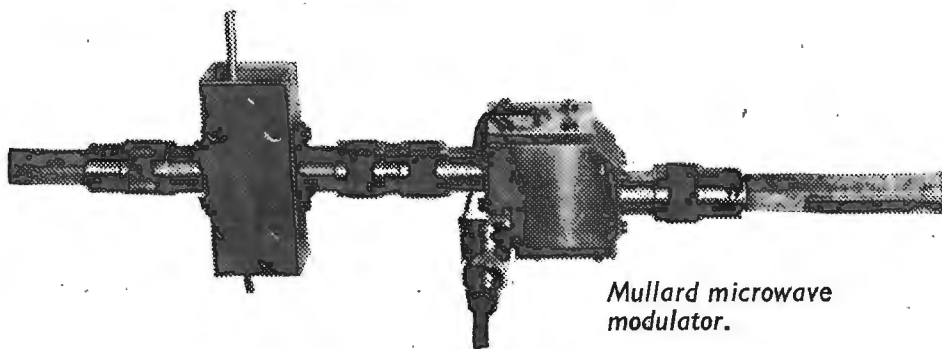

Mullard microwave modulator.

80 $\mu$ V to 2V amplitude. The rise time is approximately 3 ns. A wide variety of high-speed complex waveforms are possible by modulation of the square-wave output using the delayed pulse generators singly or in combination. A pre-pulse output is available having adjustable polarity and a pulse width of 20 ns. The delayed pulse generators all have controllable delay from this pre-pulse using the main output as a trigger pulse. All three d.p.g. units are triggered by the trigger source unit and have calibrated delays and main pulse widths. The three outputs may be used separately or mixed without loss of calibration accuracy.

A pulse produced by discharging a cable delay line with a mercury relay mounted coaxially for matching into 75 ohms is used as the basis of the E.M.I. pulse generator Type 2. This generator produces pulses of various widths with rise times of less than 0.5ns. The pulse amplitude is continuously variable from 0 to 150V positive or negative. Three internal cables are provided giving pulse widths of 4,50 and 100ns. An external cable may be used to produce pulses of any required width. The relay gives a p.r.f. in excess of 300 p.p.s. It can produce a single pulse or a continuous train.

A wide-band RC oscillator using ten basic components, of which the only two capacitors are those required for frequency determination, was shown by the Admiralty Surface

Weapons Establishment. This oscillator is a directly-coupled current-fed Wien bridge type. Equal resistances and reactances are chosen in the frequency-sensitive bridge arms; a current gain of 3 is thus required to maintain oscillation. This gain is determined by the ratio of two resistors; one, a thermistor, is used to give amplitude stabilization despite possible minor changes in the gain requirement over the working frequency. Switching capacitors giving steps of 10:1 control frequencies. Fine frequency control is achieved by switching resistors in discrete steps but this system can be replaced by a continuously-variable 2-gang control of high linearity. The oscillator has a frequency rate of 16c/s to 4 Mc/s.

Another transistor oscillator, the Levell Type TG 66A, covering a frequency range from 0.2c/s to 1.22 Mc/s was introduced at the exhibition. Frequency selection is made by four in-line additive decade controls and a five-position multiplier switch. The last control is continuously variable so that any frequency may be selected with a discrimination better than  $\pm 0.05\%$  above 10c/s and better than  $\pm 0.005c/s$  below 10c/s. Frequency stability in terms of ambient temperature change is better than  $\pm 0.03\%$  per  $^{\circ}$ C. An unusual feature is that the current-fed dual of the usual Wien is not preferred. The high impedance necessary is obtained from a super-alpha pair.

A d.c. Wheatstone bridge incorporating a number of new features designed for measurement of two-terminal resistors ranging from 0.1 ohm to 100 megohms was exhibited by the Cambridge Instrument Co. Ltd. The accuracy of adjustment of this instrument is to within  $\pm 0.005\%$ . The bridge fitted with ratio arms consisting of two sets of four coils giving values of 10, 100, 1,000 and 10,000ohms each provides seven bridge ratios from  $\times 0.001$  to  $\times 1,000$ . The two sets of coils are controlled by separate switches and are so arranged that when the instrument is used as an equal-ratio bridge the ratio coils can be interchanged and intercompared. When used as an unequal-ratio bridge any of the coils can be used to establish the ratio. A guard circuit provides a means of eliminating errors due to leakage when using higher resistance ratios. In order to determine whether or not leakage errors are present this circuit can be switched out at will. In addition to conventional battery reversing and battery series resistance controls the bridge is fitted with a means of balancing out lead resistance. This is done by three cascaded adjustable resistors of relatively low accuracy of adjustment which are connected in series with the measuring arm decades. It effectively subtracts the lead resistance from the main measurement enabling the true value of the resistor under test to be read directly.

Low switch resistance, small contact resistance variation and negligible maintenance were emphasized in the W. G. Pye Five Dial Wheatstone Bridge. This bridge was built around their Type 6001 low resistance precision instrument switches. These switches are characterized by contact resistance variation of less than  $\pm 20\mu\Omega$ . The five-dial standard gives resistance in decades of 1,000, 100, 10, 1 and 0.1; the ratio



arms consist of 1,000, 100, 10 and  $1\Omega$  resistors. Operating keys are provided for battery and initial and final galvanometer sensitivity.

The switch demonstrated with the bridge on show was developed for multiway switching applications. Basically a hundred-way switch; fewer ways can be provided on request.

The X-band solid state source demonstrated by Microwave Associates Ltd., employed silicon varactor diodes. A v.h.f. oscillator, crystal controlled, followed by a transistor power amplifier and varactor multiplier stages may be adjusted to give an output at any desired microwave frequency. A stability of 1 part in  $10^7$  may be attained. The fixed frequency unit as shown gave an output of  $10\text{mW}$  at  $8.2\text{ Gc/s}$ . A d.c. power supply of  $12\text{V}$  at  $200\text{mA}$  was required. The overall size of the unit, less power supply, was  $6\text{in} \times 4\frac{1}{2}\text{in} \times 4\text{in}$ .

A microwave modulator designed to operate within the frequency range  $2.5\text{ Gc/s}$ - $7.5\text{ Gc/s}$  without tuning shown by the Mullard Research Laboratories can be applied to low-level microwave power control.

The modulator employs a pair of variable resistance diodes and a  $3\text{dB}$  directional coupler. The incident power from the driver stage is transmitted through the coupler only when a pair of similar terminating diodes are biased to either high or low resistance condition. If the diodes are biased so that their resistance equals the output impedance of the coupler the incident power is absorbed in the load formed by the diodes. The device is thus matched to the source and load in all operating conditions. The diodes used in the modulator are junction diodes made up from a sandwich of p-type, intrinsic and n-type semiconductor material.

ceeds the input limits. A moving-coil meter on each channel indicates presence of carrier during record or playback. The reproduced signals emerge at the output socket at unity gain with respect to the recorded signals. Phase distortion is held to less than  $\pm 2^\circ$ .

The sensitivity of a transformer ratio arm bridge to small changes of resistance is well known. This used in conjunction with an a.f. oscillator, amplifier and a phase-sensitive detector enables an extremely sensitive control system to be developed. Hatfield Instruments controller Type LE460 is based on this combination. Sensitive elements of either sign placed in one or both arms enable a differential to be determined to a sensitivity of  $0.02\%$  when referred to a bridge arm resistance of  $250\text{ ohms}$ . When this instrument is used as a temperature controller it is fitted with a standard adjustable arm on one side of the bridge. Terminals for connection to the external sensing element form the other arm. Sensing elements suitable for this arrangement are platinum wire resistances or thermistor devices depending on whether positive or negative signs are required. When the bridge is unbalanced by a change of resistance in the control element a signal is fed to the input of the amplifier and then to the phase detector. When the bridge is unbalanced in one direction the output from the detector is zero and increases proportionately to the unbalance in the other direction. It is possible to select on which side of balance the control signal is obtained thereby enabling proportional control uses.

Temperature control by thermocouple is by far the more common

## INDUSTRIAL ELECTRONICS

Many methods are available for the recording of electrical outputs from transducers used in industrial monitoring and control. The main requirement is that the information may be conveniently stored for subsequent investigation and analysis. At one time the paper strip with pen tracings reigned supreme. The introduction of magnetic tape shows an improvement over paper charts in that the recorded information can be fed back directly into simulators, analogue computers, etc. When more than one signal is recorded simultaneously, the correct synchronization one to another can be

maintained during reproduction. This facility allows a time scale to be introduced to a recording. The Fenlow 2-channel tape recorder Type S.T.R. provides in the same unit, facilities for recording and reproducing on two channels signals between  $-1$  and  $+1$  volt from  $0$  to  $100\text{c/s}$ . The recorder uses  $\frac{1}{4}$  inch magnetic tape and an uninterrupted running time of 45 minutes on standard reels is possible. Use of oversize reels increases the time to 1 hour. Silicon transistors are used throughout. On each channel an overload signal flashes repetitively whenever the applied signal ex-

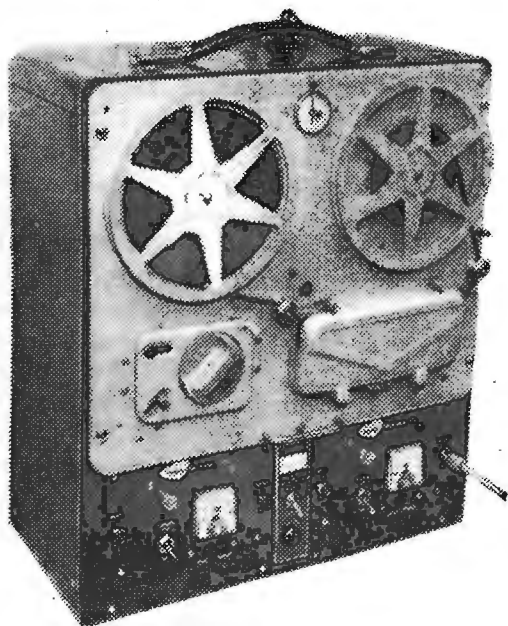

Fenlow 2-channel tape recorder.

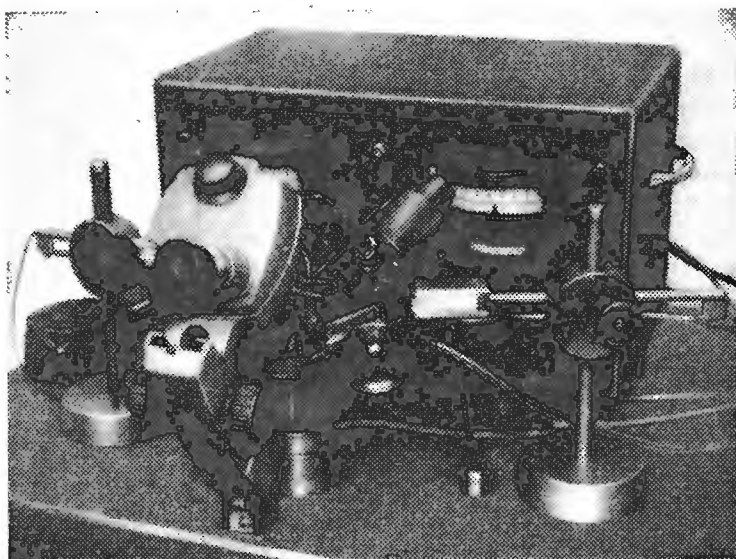

G. V. Planer thermo-compression bonder.

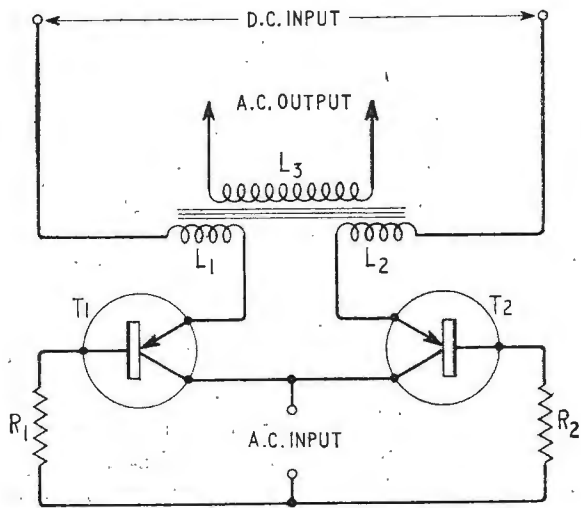

Chopper circuit of Fielden Electronics temperature controller.

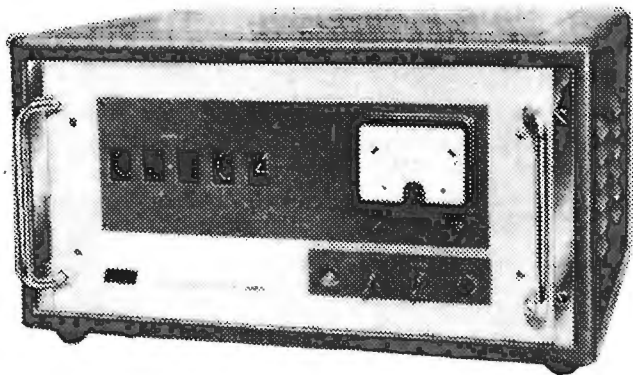

Racal reversible decade counter.

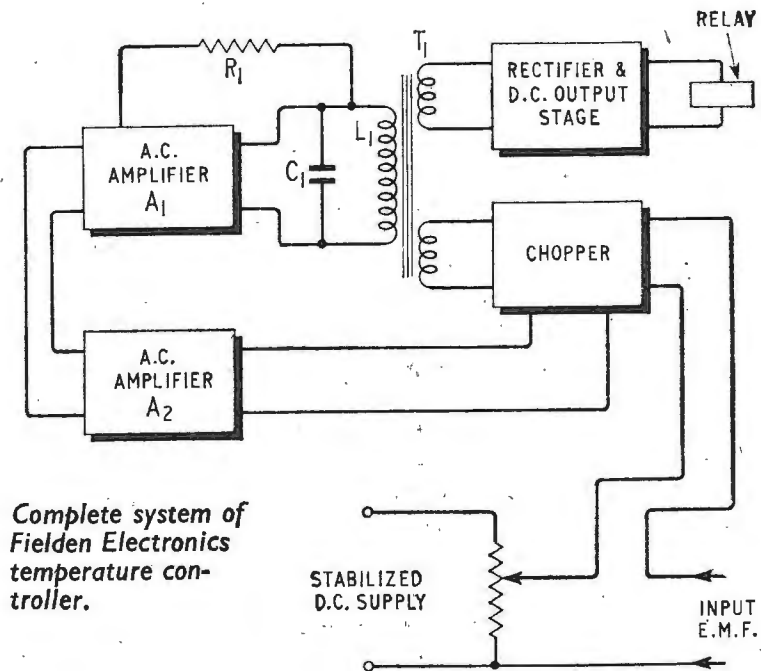

Complete system of Fielden Electronics temperature controller.

practice. In the Fielden Electronics transistorized thermocouple temperature controller a d.c. amplifier is used to compare the e.m.f. from any thermocouple with the voltage at the movable contact of a slide-wire. A current of up to 40mA at 12V d.c. is switched when the thermocouple e.m.f. exceeds the voltage at the movable contact. This contact is directly coupled to a pointer on a scale calibrated in temperature. The current can be used to energize a relay or to perform any other function required.

The compensated chopper circuit is shown in the first of the accompanying diagrams. T1 and T2 are two transistors of matched characteristics. L<sub>1</sub> and L<sub>2</sub> are two matched inductances forming the primary windings of a transformer, the secondary of which is L<sub>3</sub>. The transistors are driven in phase by an a.c. limited in amplitude by resistors R<sub>1</sub> and R<sub>2</sub>; thus they are switched on and off simultaneously. When in the conducting state pulses of d.c. flow through the circuit giving an a.c. output at L<sub>3</sub>. Unwanted alternating e.m.f. from the a.c. drive appearing across the transistors are equal and opposite. In practice the a.c. drive is derived from a separate transformer winding allowing the input terminals of the chopper to be d.c. isolated from associated equipment. The second diagram shows a

complete arrangement of the equipment. L<sub>1</sub> and C<sub>1</sub> form a resonant circuit tuned to 1,500c/s. The amplifier A<sub>1</sub>, with positive feedback via R<sub>1</sub>, is arranged to maintain the circuit at oscillation at about half maximum amplitude. T<sub>1</sub> has two output windings, one driving the chopper, the other providing a voltage which is rectified and used to switch the output current. The a.c. output from the chopper is amplified by A<sub>2</sub> prior to being applied to the input of A<sub>1</sub>. The signal at this point adds to or subtracts from the existing positive feedback obtained through R<sub>1</sub>, thus controlling the amplitude of oscillation. This arrangement allows the amplitude to rise from zero to maximum for a few microvolts change of input. A trigger circuit eliminates as far as possible relay "chatter."

An equipment developed for the production of thermo-compression bonds, particularly suited for bonding leads to thin film electrical circuit elements and semiconductor materials was exhibited by G. V. Planer Ltd. The workpiece is mounted on a thermostatically controlled base plate suitable for temperatures up to 600°C. An inert gas can be plied on this plate which can also be moved in the horizontal plane. A temperature-controlled (up to 600°C) stainless steel bonding head with variable load is used to effect the junction. The head can be

moved in both horizontal and vertical planes. A wire feed appliance in conjunction with a micro-manipulator is used for the advancement and positioning of the wire or metal strip to be bonded. Designed to accept standard spools and wires between 0.005in and 0.01in diameter the wire feed mechanism has provision for advance and reverse wire feed directions. A wire cutter is mounted at the nozzle of the wire feed channel. A binocular "zoom" microscope with continuously variable magnification and adjustable illumination is incorporated.

The measurement of an a.c. voltage in the presence of other voltages of higher potentials and differing frequencies has always presented a problem when ease of measurement and portability of test equipment were the main considerations. The Avo Frequency Selective Signal Voltmeter was designed with these considerations in mind. The instrument demonstrated at the exhibition was developed for the measurement of voltages used in railway track signalling systems. Three parallel-T-derived networks form the filtering circuits. In this case one of the networks rejects 50c/s interference of up to 100V r.m.s. The others reject interference at 100 and 150 c/s. All three networks allow free passage to low level signals of the order of IV r.m.s. at frequencies of 75 and 83.3c/s. The filters are tuned for a high degree of rejection at the unwanted frequencies and each is associated with a transistor amplifier, the three amplifiers being in cascade. In each amplifier the filter forms part of the forward signal path and negative feedback serves to sharpen the response of the filter in the neighbourhood of the rejection frequency. This



enables the very high slope of the insertion loss characteristic, necessitated by the close proximity of the interfering and signal frequencies to be attained.

Three voltage ranges (3, 15 and 30V) are provided for the measurement of the signals at 75 and 83.3c/s. In addition, a normal 150V, 50c/s range and two d.c. ranges (3 and 15V) are provided. The d.c. ranges are arranged to enable d.c. measurements to be made in the presence of up to 100V, 50c/s interference. A standardizing oscillator is incorporated to enable the sensitivity to be corrected for changes of gain.

A reversible decade counter completely transistorized and developed for work in machine tool control, etc., was shown by Racal Instruments Ltd. The instrument has an in-line digital display which is connected to the counting circuits via a transistor decoding and drive matrix. The counter comprises a number of cascaded reversible decade scaling units capable of operating at a maximum frequency of 100kc/s. High-speed input amplifiers and shaping circuits together with direction discrimination logic circuitry enables detection of the direction of travel of the measuring heads. The instrument can accept several forms of input signal, the most common input being two or more sine waves at 90° phase difference. The relative lead or lag of those signals indicates direction of movement. Where angular position is required to be displayed by the read-out it can be indicated in degrees, minutes and seconds directly.

A technique having wide applications in the design of computer power supplies and three-phase d.c./a.c. inverters was demonstrated by Transiron Electronics. The exhibit consisted of an anode commutated silicon-controlled rectifier (SCR) ring counter sequentially triggered by pulses generated from an SCR pulse generator. Selection of commutating capacitors determines the cisoidal waveform across any diametrically opposite terminal of the ring. The larger the number of stages, the better the sine wave shape. With N stages, N/2 phases of supplies may be generated each differing in phase by 360/N/2 with balanced loads the phase shift between stages is accurately defined by this relationship. If switching is symmetrical, harmonic distortion is mainly contributed by the switching frequency which is N times the output frequency.

## MISCELLANEOUS

**Levitation** is fast losing its whimsical character, and industry may well benefit from the process in the foreseeable future. Previous demonstrations have required some means of stabilizing and balancing the supporting field, but the N.R.D.C. demonstration by D. H. Cashmore and E. R. Laithwaite is considerably simplified. The device takes the form of several hundred E-type transformer laminations arranged in two rows, thus providing four slots. Copper bars are placed in the slots and alternating current passed through in such a way that flux from each slot opposes that from adjacent ones. If a conducting plate is placed over the assembly, eddy currents are induced in it, and a repulsive force set up. The flux from the inner slots supports the plate while the outer field stabilizes it in a central position. The space between the two sets of laminations can be occupied by a linear motor, the result being a completely frictionless system. A problem to be solved is the fact that eddy currents heat up the plate, increase its resistance and decrease the currents.

**Cathode-ray tubes** with several new features were seen at the exhibition. A camera tube by 20th Century Electronics is intended for ultrasonic applications in medicine and industry, where X-ray techniques cannot be used. In operation, the tube is something like a vidicon, the charge pattern being set up on the inside of the transducer. The pattern is scanned by a low-velocity electron

beam and the signal picked off capacitively from the outside surface of the transducer. Cathode-potential stabilization is obtained by ionization set up by the electron beam between the decelerator screen and the transducer. The operating frequency of the transducer is 4Mc/s.

High-sensitivity magnetic deflection is provided in a new E.M.I. tube. The coils, instead of being mounted externally on a deflection yoke, are fitted in place of the normal electrostatic plates. The coils are formed by a printing process, and, being nearer to each other than is normal, produce a greater degree of sensitivity—of the order of 100° per ampère of deflecting current. The signal required is current rather than voltage, and transistors would appear to be the ideal amplifiers for this application. The inductance of the coils is 8μH. It appears possible, by the provision of a centre-tap, to use the coils as an electrostatic deflection system, simultaneously, although cross-talk then becomes a problem.

At low light levels, the performance of the normal image orthicon is degraded by leakage between elements of the target, and at a brightness of 2 foot lamberts with an aperture of f.16, the screen is capable of resolving only 200 lines. In a new English Electric tube, the inter-element leakage has been considerably reduced, and the resolution is 350 lines. The process has also reduced the after-image effect at normal light levels.

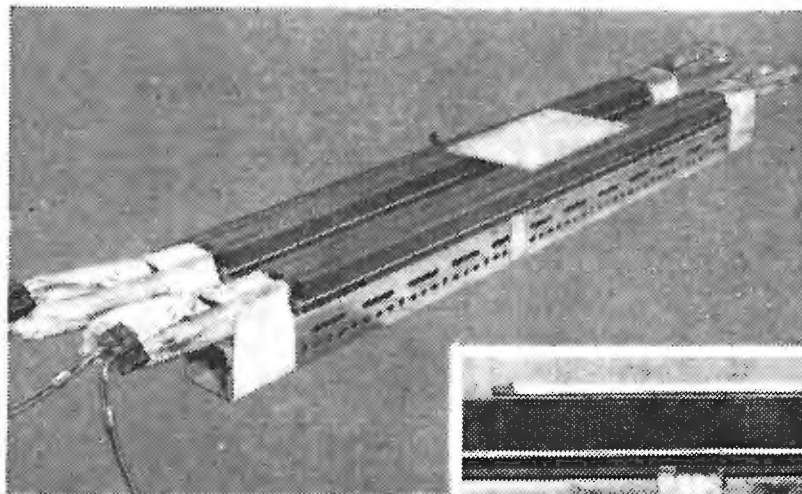

N.R.D.C. levitator.

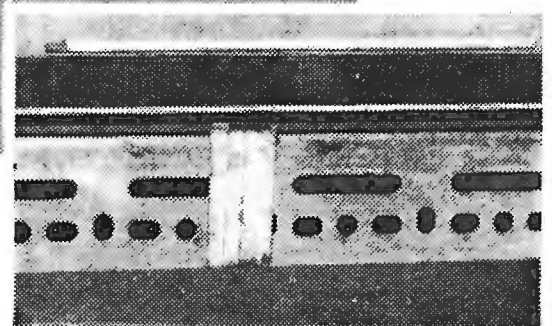

# LETTERS TO THE EDITOR

The Editor does not necessarily endorse opinions expressed by his correspondents

## "New Phase-splitter"

IN his letter in the January issue Mr. Baxandall takes me to task over my criticism in an article in the Sept. 1962 issue of the concertina phase-splitter.

Now although I realize that the ideal state is for amplifiers to be driven within their ratings, I feel that it is unrealistic to ignore the possible effects of overload. Indeed the testing specifications laid down by several associations of amplifier manufacturers and other important bodies includes the testing under overload conditions. Most amplifiers are liable to be overloaded and it is very distressing if an amplifier indulges in a fit of hysterics for several seconds after an overload.

The greatly dissimilar, but coupled, output impedances of the concertina phase-splitter can help to cause this defect and the application of overall negative feedback can easily make matters much worse. This is perhaps best seen by considering the conditions that apply in both balanced and unbalanced drive impedances.

The block diagram of a balanced system is shown in Fig. 1 along with the waveforms associated with a suddenly applied sine-wave overload. The effect of the overload is to cause the output valve grids to back-bias due to the flow of grid current. The bias will, however, be equal for both valves as the system is balanced. The valves may easily bias back to class B operation if not beyond, but when the overload ceases they will rapidly return to their correct working point. As the system is balanced there will be no effective d.c. component in the output transformer windings.

If the concertina phase-splitter is now considered, we find that things are no longer the same. This is shown in Fig. 2. The output from the cathode side is at much lower impedance than that from the anode side. Hence for a given overload the output valve driven from the cathode side will tend to take a much larger grid current than the one driven from the anode side. The grid circuit driven from the cathode will, therefore, self-bias much further towards cut-off than the other one.

In addition, the limiting imposed by the output valve grid current on the cathode output voltage of the phase

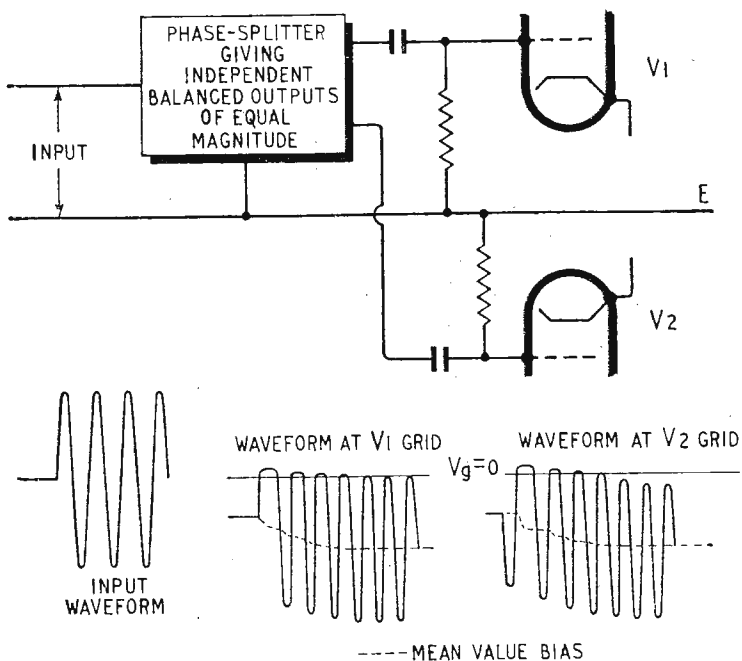

Fig. 1

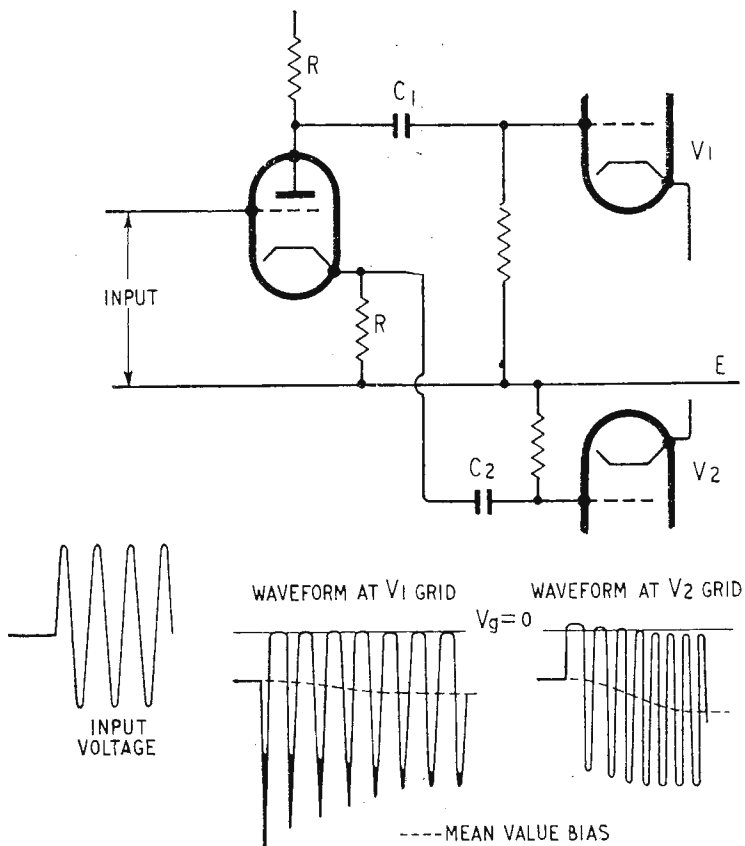

Fig. 2

inverter produces large negative-going spikes on the anode output voltage. It is now seen that there is a large difference between the standing currents in the two output valves. This difference can easily saturate the output transformer and thus severely reduce the output.

If overall negative feedback is present on the amplifier, this reduced output will cause the drive to the output valves to be greatly increased and thus make matters still worse. This defect in performance is not just surmise and has been observed in practice. One could presumably fit limiters to the amplifier input but I personally feel that a safe self-limiting circuit is preferable.

Apart from the question of overload, the concertina phase-splitter gives a gain of about twenty times less than the long-tailed pair. With large amounts of feedback this loss of gain can easily cause the required input voltage to become excessive.

On the question of stability there is no doubt that the concertina phase-splitter is far better than the conventional type of long-tailed pair. It would be interesting to try a normal long-tailed-pair phase inverter in Mr. Baxandall's amplifier using an identical feedback-loop gain. I have a suspicion that it would make the stability far worse even if oscillation did not ensue.

Regarding the subjective assessment of amplifiers: I feel that the only way of doing this is by means of A/B checks with impeccable signals and the best loudspeakers obtainable. The room used for the tests must be absolutely quiet and plenty of time taken over the tests. The last thing necessary—and the most important—is a keen ear. Under these conditions it is surprising what differences can be detected, even today, between amplifiers.

In conclusion I would like to say that I do not profess to have produced the last word in phase inverters. It is

felt, however, that the circuit described possesses to a large degree all the requirements of a phase inverter, without becoming too complex and uneconomic.

ARTHUR R. BAILEY.

### “Pulse Modulated AF Amplifiers”

IN view of the article under the above title in the February issue on an audio power amplifier using power switching (a mode of operation which P. J. Baxandall suggests should be called “class D”), readers may be interested in a circuit which I have developed using this same principle. The output power obtainable is greater than 1W and I have used it to drive a 15Ω speaker from a normal crystal gramophone pickup. Only five small transistors are used and they remain substantially cold in operation whilst the “quiet” power consumption is in the region of 15mA from the 10V battery. The level of distortion is low as direct overall feedback from the output to the input is an essential feature of the circuit. A typical assembly with normal components occupies 12 cu in and weighs 4oz, excluding, of course, the battery and loudspeaker.

The circuit is shown in the diagram and the operation is most easily explained by working backwards from the output terminals. First the inductance  $L_1$  is added in series with the speaker to give a total series time-constant with the speech coil of about 50μs. This serves as a filter to confine the high frequencies generated by the fast switching of the power stage as far as possible, to prevent radiation, and also to reduce the loading on the fast edges due to the capacitance of a long loudspeaker cable. At the same time the efficiency is improved as less switching frequency power is dissipated in the speech coil and, last but not least, a high-frequency “roll-off” is obtained to match the pre-emphasis normally used in disc recording. The value of  $L_1$  may typically be 0.5mH and it can be wound on a ferrite core. Care must be taken that there is sufficient air-gap to prevent saturation at currents approaching 0.5A and, of course, the d.c. resistance must be small compared with the 15Ω of the speech coil.

The transistors V4 and V5, which should be similar but need not be accurately matched, form a p-n-p/n-p-n pair of which one is cut-off and the other driven into saturation alternately at a frequency of about 50kc/s.

The diodes D2 and D3 are necessary to prevent difficulty when their respective transistors are required to carry large reverse currents during the peaks of loud low notes, since the reverse current-gains, even of alloy transistors, are normally insufficient to ensure saturation under such conditions. Note that not only the emitters but also the bases of these transistors are directly cross-connected, and thus the danger of their both conducting together is eliminated. The collectors of these power transistors are connected to the negative and positive poles of the battery respectively, but notice that the battery is not centre-tapped. The return current from the speech-coil is taken to the centre point of a pair of large capacitors connected in series across the battery, and this same centre rail is used at several other points in the circuit. These two capacitors are by far the bulk-iest components in the whole amplifier.

The drive to the bases of the power stage is taken from V3 through the capacitor  $C_5$ . The load resistor  $R_{13}$  in the collector of V3 is taken to a floating-power-rail voltage generated across  $C_6$  by the diode D1 in a bootstrap type of circuit. This enables V4 to be driven hard into saturation when V3 is cut-off whilst at the same time allowing V5 to be driven equally hard when V3 is itself saturated. The drive to the base of V3 comes through a straightforward coupling network from the collector of the n-p-n transistor V2 and the base of V2 is driven partly from the collector of V1, and partly by positive feedback through  $R_8$  and  $C_3$  from the collector of V3. This positive feedback makes these stages act as a toggle and snap sharply from the off state to the saturated state at a particular value of the voltage at the collector of V1 and to snap back at a slightly different value of this voltage.

The transistor V1 now functions as a Miller integrator with the capacitor  $C_1$ . The current at its input is the linear sum of a term from  $R_1$  due to the input signal and a negative feedback term through  $R_2$  from the output of the power stage, whilst it is the output voltage of this integrator which trips the toggle circuit of V2 and V3 and so switches the power stage V4-V5. This in turn reverses the current through  $R_2$  and sets the integrator running back towards the other tripping voltage so that the circuit oscillates continuously. Notice that the capacitor  $C_1$  controls the frequency of operation and its value should be adjusted as necessary to obtain running at about 50kc/s. Too low a frequency may generate

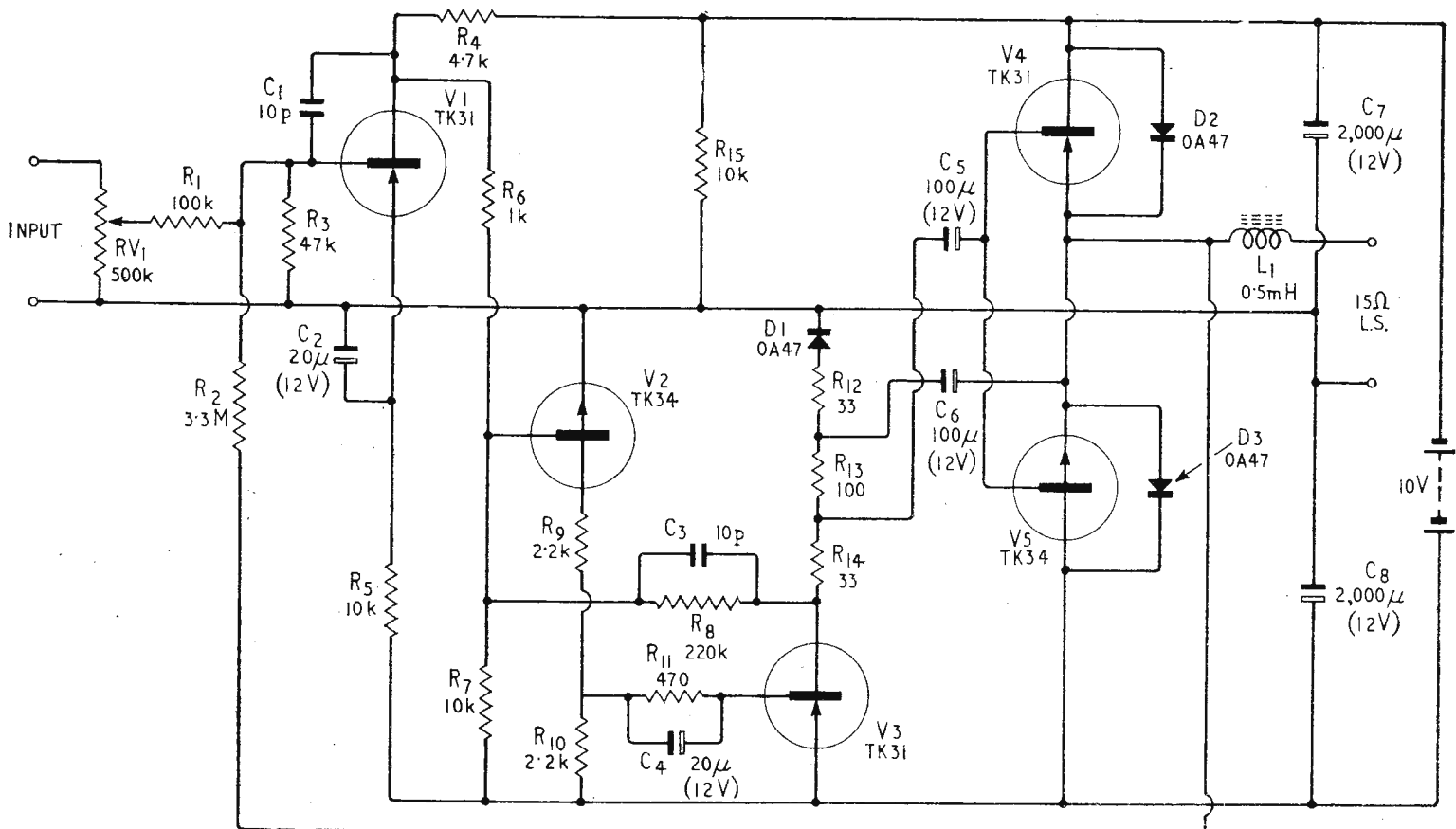

distortion from cross-modulation whilst too high a frequency makes the power stage unnecessarily inefficient.

In the absence of any signal current from  $R_1$ , the voltages across  $C_7$  and  $C_8$  adjust themselves in a few tenths of a second so that the mark/space ratio is very close to 50/50.  $R_1$  may need to be varied slightly if the ratio is not sufficiently exact. Any input signal, however, upsets this balance and, moreover, does so in such a manner that the net current into the integrator remains close to zero whilst the mark/space ratio changes appropriately. Hence the mean voltage applied across  $L_1$  and the speech coil of the loudspeaker changes in exact proportion and there is a powerful overall negative feedback effect fixing the voltage gain from the slider of  $RV_1$  at a factor  $R_2/R_1$ , that is 33:1 with the component values given. The current gain, however, is in the region of 200,000:1 and these values are adequate for ordinary use with a crystal pickup.

The resistor  $R_{15}$  in the circuit is included solely to ensure that the oscillation starts correctly when first switched on. Without it the voltage across  $C_8$  might collapse, due to leakage through  $R_8$ , and the transistors V2, V3, V4 and V5 would all remain turned off. Even with  $R_{15}$  included the circuit may occasionally switch-on to a state where V3 conducts a small steady current, but the application of a moderate input signal initiates correct operation and once started this will continue until the power is switched off.

The circuit diagram shows S.T.C. transistor type numbers, but other makers are now offering fast high-gain germanium alloy devices of both p-n-p and n-p-n polarities which can almost certainly be used without any need for changes in the component values shown. If a diffused transistor is used for V1 then  $C_1$  will almost certainly need to be increased, whilst a fast silicon device at V3 would allow the components  $R_{11}$  and  $C_4$  to be shorted out altogether.

The circuit as shown here is sensitive to ripple on the power supply and hence battery operation is recommended. It is expected, however, that further development will allow this difficulty to be overcome. Again the author has a version of the circuit in which the two power transistors V4 and V5 are of the same polarity, being driven from the collector and emitter of V3 respectively, but although this circuit has, in fact, worked over many months there are severe transients during switching-on which considerably exceed the ratings of the transistors and the circuit is not, therefore, suitable for publication in its present form. In any case satisfactory n-p-n germination devices are now readily available so that there is little need for such a version of the circuit.

These last remarks may, perhaps, encourage readers to experiment with circuits of this type for themselves and the writer is quite sure that much progress remains to be made before any circuit will emerge that could be called conventional.

Cheadle.

K. C. JOHNSON.

## The *Wireless World* Quality Amplifier

I WONDER how many *Wireless World* Quality Amplifiers are still in service? Shortly after the publication in December 1943 of the "Wartime modifications to a well-known design," when 6V6's with feedback were suggested as substitutes for the hard-to-get PX4's, a friend and I co-operated in building one each. Mine was put into daily domestic use for radio and gram in 1946, and continues to this day. The tiny thing in the cot when the "*W.W. Quality*" started its career is, at the moment I write, feeding delightful Paraguayan folk-music from a tape recorder through it (the amplifier), in the manner of many of her fellow-teenagers. Faults in that time? One 6J5G, substituting for an L63, which was second-hand when it went into service, has failed, and last year the smoothing electrolytics went open-circuit.

I believe that it was in January 1946, in an article on the "genus *W.W. Quality*" generally, that *Wireless World* wrote modestly of the virtues of a good design which does not run its components to their limits. Well, my 16-odd years of service demonstrates this. The things that come before the power amplifier, and those that follow it in the reproducing chain, have been changed with changing years.

But what comes out the loudspeaker, owing much to a design you prepared in the 'thirties, is still what Ralph West calls "a nice noise." Overall feedback? Ultra-linearity? High efficiency? One day, perhaps, when I have a disruptive fault on my present power amplifier, I'll make this change from Quality to High Fidelity!

St. Albans.

L. F. KEEL.

## Transistor R-C Oscillators and Selective Amplifiers

THE article by F. Butler in your December 1962 issue presents a very comprehensive and lucid survey of the subject. However, when discussing the techniques for stabilizing the output level of R-C oscillators, the use of thermistors is criticized on the grounds that excessive power must be dissipated in the thermistor if the effect of varying ambient temperature is to be swamped. Your readers may be interested to hear of the STC type R thermistor produced specifically for low-level work in transistor circuits. No more than 3mW is required to raise the bead temperature to 150°C. This should be adequate to swamp the effect of room temperature variations!

Footscray, Kent.

S. C. RYDER-SMITH,  
Transistor Applications Dept.,  
Standard Telephones and Cables Ltd.

## "Analysis of the Bootstrap Follower"

IN deriving my expression for the gain of a bootstrap follower I made the simplifying assumption that the direct contribution of the input current to the output current is negligible. This is true of the vast majority of practical circuits, in which grid resistances of about

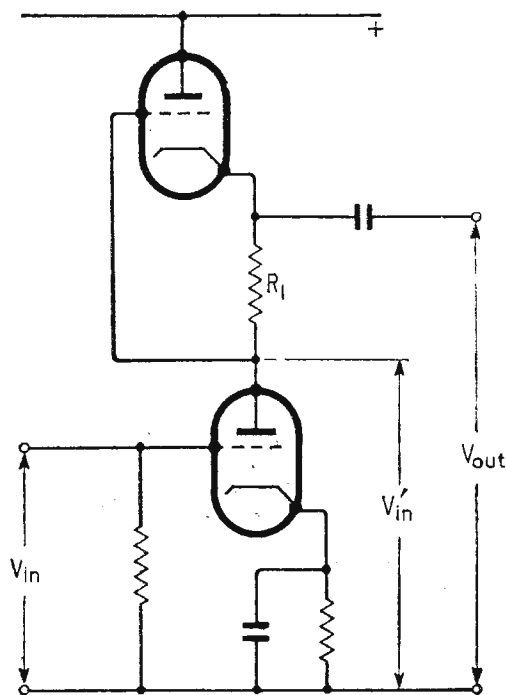

a megohm are employed. However, the rigorous formula given in Mr. Butler's article (January, p. 22) should be used in the case of circuits like the one shown here, and where the grid-cathode resistor of the follower valve ( $R_1$ ) has a much lower value than usual. (The relevant gain here is  $V_{out}/V'_{in}$ .)

Croydon.

G. W. SHORT.



## is one speech channel enough?

If your H.F. radiotelephone circuits are pushed to the limit or if you find new planning difficult—you need **Rediplex** for maximum utilisation and lower operating costs. Now for the first time, at low capital cost, Redifon introduce a compact ISB multi-channel system for short and medium distance communication. Four speech channels simultaneously using one carrier. The cost of the transmitting and receiving terminals, including the channelling, is far less than you would pay for regular channelling and displacement equipment—a quickly installed packaged deal. It will pay you to find out more about Rediplex. Write now for full specifications.

## The Rediplex system gives you

Four simultaneous speech channels, or any combination of speech, teleprinter, facsimile or tone intelligence signals.

Four crystal controlled spot frequencies, 2 to 16 Mc/s.

100 watts p.e.p output, continuous rating (or 750 watts with the G.A.406 amplifier).

Compatible with Standard International ISB systems.

Completely transistorised receiving terminal and transmitter drive unit.

Modular construction and printed circuits.

Alternative power supply units for a.c. mains or 24 volts battery supplies.

# Redifon

**REDIFON LIMITED** Communications Sales Division  
Broomhill Rd., London, S.W.18. Tel: VANdyke 7281  
A Manufacturing Company in the Rediffusion Group.

 Rx2





**NOT TO WORRY**

**Constant  
voltage  
is  
assured**

with a **VOLSTAT**

A VOLSTAT is the answer to many a.c. voltage fluctuation problems. In most cases, a standard type is all that is required—but there are occasions when a special design may be necessary. Either way an 'Advance' Technical Representative will be pleased to investigate your own particular problems, and recommend a VOLSTAT best suited to your needs. VOLSTAT stands for a complete range of Constant Voltage Transformers produced by 'Advance'—the leading authority on voltage stabilization.

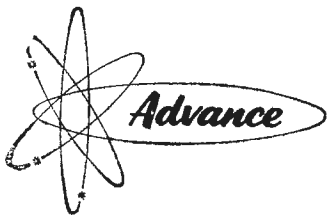
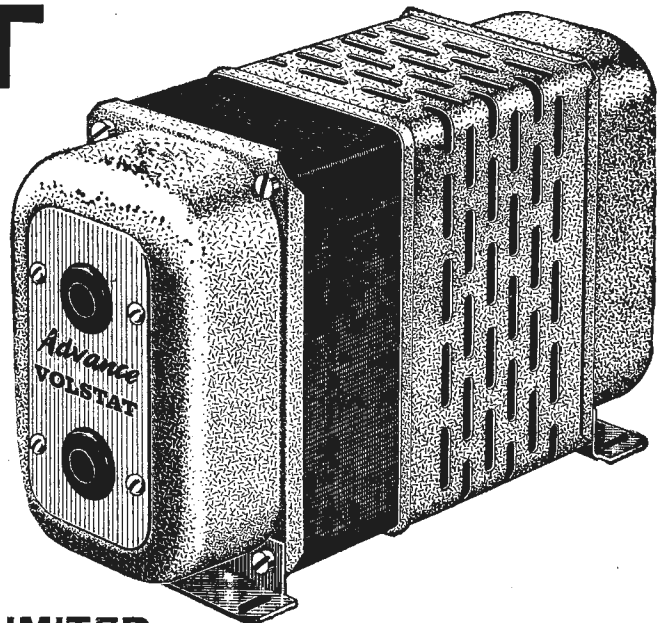

**ADVANCE COMPONENTS LIMITED**

VOLSTAT DIVISION

ROEBUCK ROAD, HAINAULT, ILFORD, ESSEX. TEL: HAINAULT 4444

SBCV/4

# OSCILLATORS: a Monistic Approach

## 3.—NON-LINEARITY, HARMONICS AND STABILITY

By THOMAS RODDAM

**I**N two previous articles we have surveyed the two broad classes which we can distinguish in the field of oscillator design. We have seen that some circuits may fall nicely into place in one or other class and that nicely is, for once, correctly used in this context. We have also seen how we are left with a few circuits which fit into this kind of scheme only with difficulty. This is a normal problem in classification and cataloguing. Throughout the discussion it has been assumed that the active system was operating in a linear region.

It is part of the dogma of oscillator theory that the highest stability of frequency necessitates freedom from distortion. This rule is attributed to Groszkowski (*Proc. I.R.E.*, Vol. 21, p. 958 (1933)) although I doubt whether anyone nowadays takes the trouble to verify this. The logic of this rule is rather simple. If there is some non-linearity we shall get components of, say,  $2f$  and  $3f$  produced at the non-linearity. These will be transmitted through the four-terminal network of a feedback oscillator with some arbitrary phases to appear again at the input. When the non-linearity is reached a component of frequency  $f$  will be produced by intermodulation and this component will not have the zero or  $180^\circ$  phase shift assumed in setting up the oscillator equation. Since this is an impossible situation the frequency must shift to bring the total fundamental into the  $n\pi$  state.

Dogma is not necessarily completely false: its great danger comes when one believes that it is completely true. We can design our active network for good linearity, we can design our feedback networks so that they reject the harmonic frequencies. This last operation is less simple than it sounds, however. Reactive filters do not absorb the signals they reject; they simply refuse to accept them. In a simple feedback oscillator, therefore, the feedback network will push the harmonics back into the valve anode, or whatever device electrode we may be taking at the output. High harmonic attenuation may not help us at all.

Quite a different approach is possible and it is this approach which I intend to consider in connection with negative resistance oscillators operating at large amplitudes. Our quarrel is not with the harmonics as such, but with the presence of harmonics which are sensitive to the operating conditions. We can arrange to operate under low-distortion conditions and keep the harmonics so small that it does not matter if they vary, but the price we must pay is the price of efficiency. We must operate at a relatively low level. The alternative approach is to fix the amplitudes and phase of the harmonics rigidly so that they do not vary.

There are a good many applications for this principle although I have rarely seen it used. Some long time ago I used it myself in a multi-frequency sig-

nalling system which illustrates its application fairly clearly. A very cheap oscillator with a very variable supply voltage can be switched to any one of a dozen or so frequencies. Filters are to be used to identify the frequency, which is the information to be transmitted. The second, and I think, though memory may be at fault, the third harmonic of the lowest frequency could fall into the pass-band of higher frequency filters if otherwise tolerable performance was accepted. The incoming tone was therefore amplified and limited, to deal broadly with the wide variations of signal level, and was then taken into a very well defined squaring circuit to provide a square wave of fixed amplitude. Although there has been an increase in the harmonic content there is a well-defined margin between fundamental and harmonic which is more than adequate for the reliable control of a trigger circuit.

The same basic idea is used by the best clock-makers. I do not know whether anyone has ever made what we might describe as a class A clock:

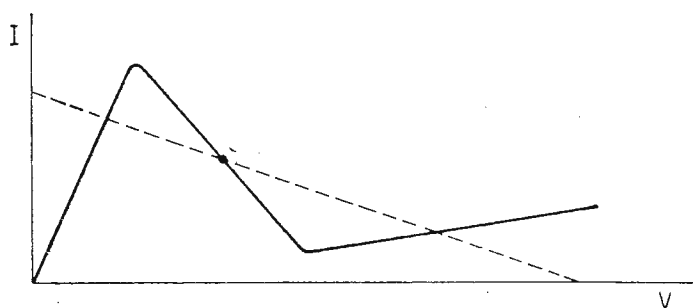

Fig. 1. Short-circuit stable negative resistance characteristic.

at least I do not know if anyone has made a low-frequency one. This change of mind is because I started to think of a design and found myself thinking first of a tuning fork drive system and then of a crystal oscillator using a four-electrode quartz crystal. In both these systems we have a mechanical tank circuit with a driving loop which can be linear. The best pendulum clocks use a pulse to maintain the oscillations in the tank circuit, and a pulse is even richer in harmonics than a square wave.

We know that circuits of the general inverter type produce quite square waves and we may begin by setting this concept down and then not taking too much notice of it. We shall see why we do this in a moment. We can use quite a lot of the concepts introduced in "Transistor Inverters: a Single View" (*W.W.*, Jan. and Feb. 1962), but we will find that we need to make some important circuit changes.

The basic concept may be considered in conjunction with Fig. 1. This is the now familiar N-shaped negative resistance characteristic which we know is short-circuit stable. A load line is sketched in, to

give the three points of intersection, and again we know that the centre point is unstable and the two outer intersections are stable. In a small-amplitude system the point C will be the point at which the circuit is centred but in a large amplitude system the point C is inaccessible. We know the sort of waveform we can expect, for we have seen a modified version of it in our studies of inverters. In an inverter we have parasitic terms which produce an anti-resonant circuit of relatively high characteristic frequency. Here the waveform will be something like that shown in Fig. 2.

In this distorted sine wave we have a section AB in which the anti-resonant circuit is being driven by the negative resistance, followed by the section BC which corresponds to the free swing of the circuit after the active device has been cut off. This is the spike region in ordinary square-wave operation. During CD the negative resistance is driving again until at D the trajectory runs into the diode

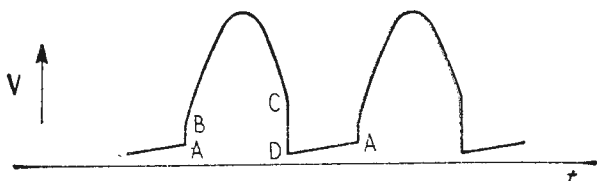

Fig. 2. Large-amplitude waveform in a negative resistance oscillator with an anti-resonant control circuit.

line and the tuned circuit is damped down hard along the region DA.

An oscillator of this type will obviously not be particularly stable, because we have in the region DA a relaxation oscillator mode which is notoriously poor in frequency stability owing to its dependence on the characteristics of the active device. Even in the region BC the active device is having some effect, for it provides some extra damping on the circuit and this damping, if the system is a transistor oscillator, will be temperature dependent.

The fact that the BC section of the waveform is fairly right is the clue to our next step. We must make the end sections of the device characteristic correspond to infinite impedance. In drawing Fig. 3 I have run slightly ahead of myself, but you can see here a short negative resistance region terminated by two regions in which the shape of the device characteristic is infinite. I do not think there is any difficulty in seeing that the waveform produced by this sort of negative resistance characteristic and an anti-resonant circuit will be of the form shown in Fig. 4. We can describe this as two half sine waves joined by short switching sections.

During most of the time the tank circuit is a completely free circuit and so the duration of the swing is fixed only by the anti-resonant frequency. The active device can only influence the duration of the switching interval. We have two available methods, in theory, for reducing the length of time the system spends in the driven mode and on close examination we find that one of them is meaningless. We might try to increase the tuned circuit swing or the size of the voltage step, without changing the actual shape of the negative resistance. What we must do, in fact, is make the negative resistance as small as possible and the tuned circuit parallel resistance as large as possible. The height of the voltage step is

then settled for us, because we shall have some limits on the size of the oscillations.

A circuit operating on this principle was described, although not exactly in this way, by Tillman (*Wireless Engineer*, Dec. 1947). The kind of circuit which we can use is simply our old friend which Terman calls a feedback oscillator. I have drawn it as a two-stage triode amplifier with biased diodes for limiting. If we say that the amplifier gain is 200, quite an arbitrary figure, the negative resistance will be  $-R/200$  so long as the diodes are not conducting. When the diodes conduct the gain of the amplifier is pretty well zero and the amplifier input resistance is  $R$ .

A typical audio-frequency tuned circuit would be 100mH with a Q of 100 at 1600c/s, giving a parallel resistance of 100,000 ohms. If we degrade the Q by 10% we have a feedback resistance of 1 megaton ohm and a negative resistance of  $-5000$  ohms. I do not claim that this is the correct design, but it gives us some numbers to look at. When we start to examine the circuits more closely we find, at least I do, that the easiest way of treating it is by the feedback method. The swing at the first grid will be one-eleventh of one swing at the second anode, if we assume that at the second anode we are measuring the fundamental. Let us assume that we can allow 1/10 volt swing at the grid, giving us 20 volts at the second anode if we just consider the gain, but only 1.1 volts swing if we consider the feedback ratio. From this we see that the circuit is under drive only for the central 1 volt of a 20-volt swing. For the rest of the time it is swinging free.

Although we could have arrived at this result by working out the negative resistance characteristics we should have needed to examine the way in which the limiting conditions arise. The diode clipper circuit is used in this explanation because this keeps the various functions separate. The second valve may well be used as a limiter rather than as a linear amplifier, but the practical designer must then examine the effect of grid current on the symmetry of the limiting. If the bias point can

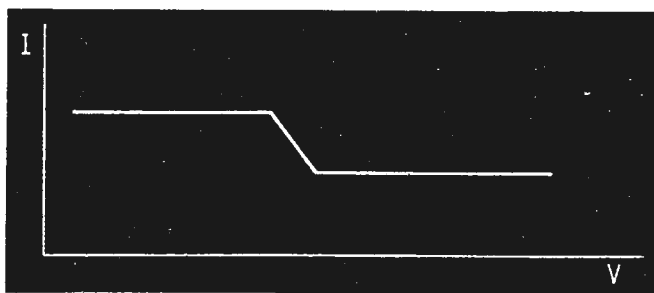

Fig. 3. Negative resistance between infinite-impedance end sections of the characteristic.

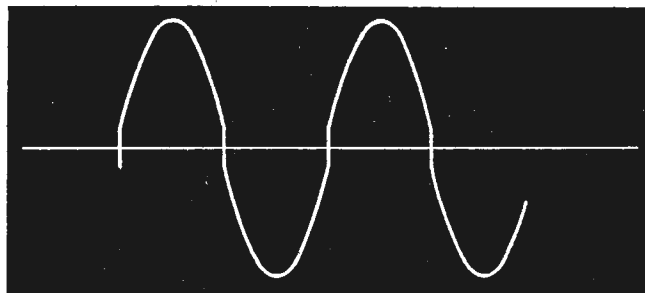
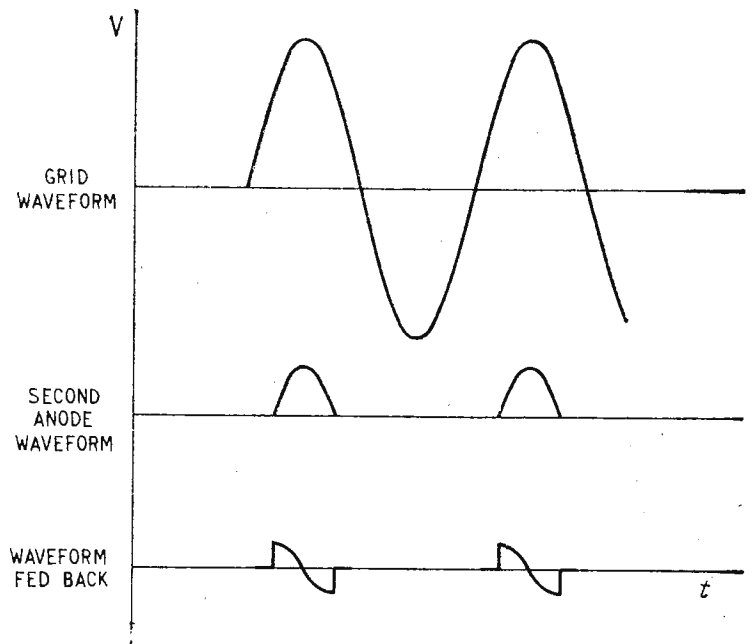
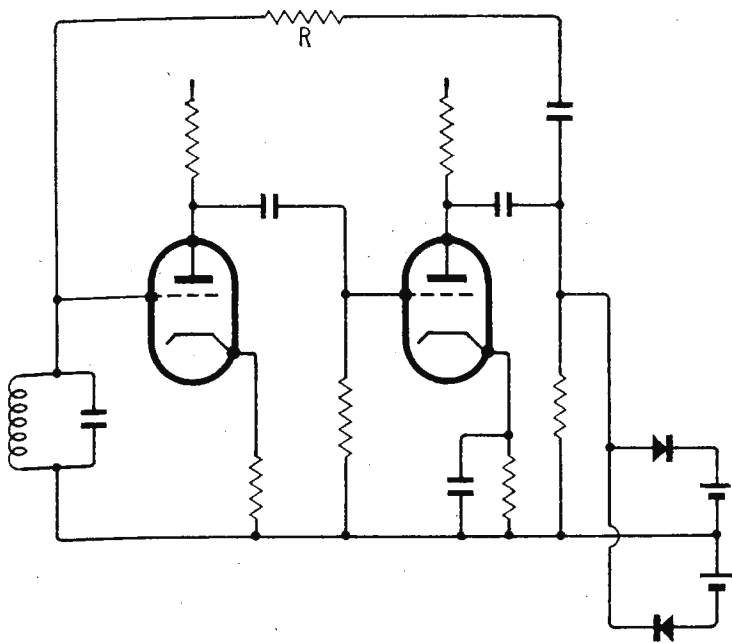

Fig. 4. Waveform associated with the characteristic of Fig. 3.



Left: Fig. 5. Two stage feedback oscillator with gain limited by biased diodes. Right: Fig. 6. Waveforms in class-C operation.

float with signal amplitude the energy pulse as the circuit passes through the negative resistance region will be de-phased and frequency stability will be lost. As shown in the figure there is no provision for loading the circuit, but a sinusoidal signal is available at the first anode and an appropriate square wave at the second anode. Since this oscillator is capable of giving high stability we may expect to use a buffer amplifier to the output.

This technique opens up a whole new range of sinusoidal oscillator techniques and also throws some new light on transistor inverter circuits. The characteristic in Fig. 1 is the characteristic seen at the collector: looking in at the base we do not see the collector diode line, because it is buffered off by the feedback resistance. In its place we see the higher resistance of the base diode line with the feedback effect from the emitter. By using compounded transistors we might get fair frequency stability in an inverter-oscillator of this kind. The negative resistance approach shows us, however, that what we need is a high gain in the amplifier circuit, for with a fixed value of feedback resistance  $R$ , the higher the gain the smaller the value of negative resistance and the shorter the duration of the perturbing drive.

There is room here for a good deal of general study, probably enough to rate a Ph.D. at a Yellowbrick University (I understand that yellow bricks are cheaper than red). We can introduce into our amplifier negative feedback to make the gain more stable, and/or positive feedback to increase the gain. The swings-and-roundabouts effect will be in operation, of course, but will not necessarily be in balance. It is a very attractive problem for anyone who wants to spread himself, because to add to the general complexity we have the desirability of putting in negative feedback to the cathode of the first valve to increase the input impedance. I have shown in Fig. 5 an undecoupled cathode resistor, but according to the rules of the game we should like to bring the feedback from the amplified input. This is a real tempter until you notice that it is not going to do any good. Since the output circuit is controlled by the limiter the gain is zero and this feedback will

only affect the input impedance during the switching interval. As you see, there is quite a lot to be learned about this kind of circuit without doing any mathematics at all. Remember, too, that it is not the specific circuit in Fig. 5 that we are talking about, it is the class of circuits of which Fig. 5 is typical.

We can get an insight into the workings of the class-C oscillators by this same method. We have seen that in a typical situation the resistance  $R$  is many times the effective resistance of the tank circuit. Let us replace the resistor by a capacitor, which we might expect to have the same sort of impedance. This will enable us to think of the capacitor as providing the familiar differentiation operation. Basically the class-C oscillator is limited on one side only. Practically we must get some peak limiting by the grid current which tops up the bias; but let us overlook this. The waveform after limiting will have the form shown in Fig. 6 (b) and the waveform fed back will begin by looking like Fig. 6 (c), though in fact the tuned circuit will change this. Now in this approach we get the "tap at the end of the swing" effect which we know from pendulum analysis is bad.

If we use the negative resistance approach we simply draw Fig. 7 in which the tip of the wave, when the amplifier is working, is a piece of a sine wave of higher frequency owing to the negative capacitance term we have slapped across the tuned

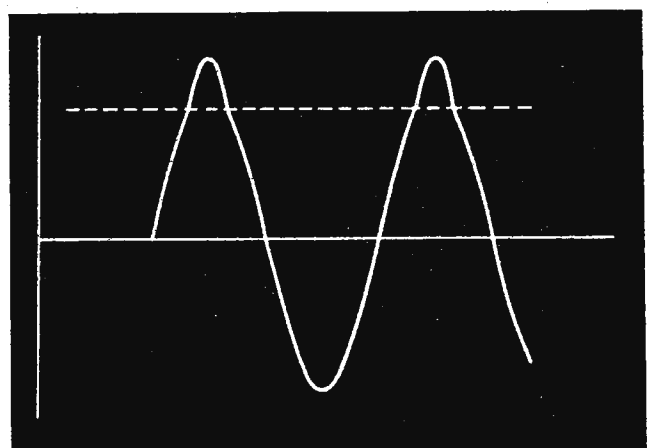

Fig. 7. Feedback at the "top end of the swing".

circuit. We get at once a direct insight into the reason why tip drive is bad, for we can see that we come slowly into this region of changed frequency and small changes of amplitude will make a good deal of difference to the triggering phase. Crossing back to the classic feedback form we are not surprised. The network is listed in "Reference Data for Radio Engineers" (I.T. & T., 4th Edition, 1956) as a 3-element shunt Type II and the image attenuation, shown in Fig 8, rises only slowly with frequency in the upper stop band. This circuit lets the harmonics get back round the loop rather early.

This philosophy points the way towards the design of an oscillator which might have some advantages. We know that we must give our pendulum a tap as it swings through the central position but we need not tap it every time. We can follow our limiter by a divider chain and drive our feedback impulse from this, giving a tap only, say, every 16 cycles, and leaving the tank circuit to oscillate freely in between. From the negative resistance viewpoint we get a gain through the chain only when all dividers are making a transition and then we get the gain of all stages in tandem. To my mind this reveals at once that we shall not have an optimum design: we shall have too many stages, none of them designed to give a good gain-bandwidth product. It will be far better to concentrate in getting a very short and correctly placed switchover every cycle.

I am tempted to say that this class of switching oscillator in the form which uses an open-circuit stable negative resistance and a series resonant circuit is of no interest whatever. Obviously there is some theoretical interest, but it is much more difficult to make an amplifier with an input resistance which is low enough not to degrade the Q of a series circuit, than one with a high input resistance which will not damp an anti-resonant circuit. The problem is made more difficult by the lack of a d.c. path through the circuit. Probably the most likely form of tuned circuit for this purpose will be a crystal, particularly a partially plated crystal with its very high inductance. I shall leave this as an example for the student.

The switching type of negative resistance oscillator, as we have already seen, encourages us to think about the switching type of four-terminal feedback oscillator. We started off with the idea that by fixing the harmonic content we should get the same sort of stability whether we fixed it at small value or a large one, provided we "fixed it good." Let us consider a system like the one shown in Fig. 9 (a). The half-section of band-pass filter feeds a fairly good sine wave into the amplifier and this drives the limiter to generate a well-squared output. In its basic form we may say that the amplifier is fed with a perfect sine wave of constant amplitude and must be designed for zero phase shift and no distortion, at least no distortion which can affect the crossing

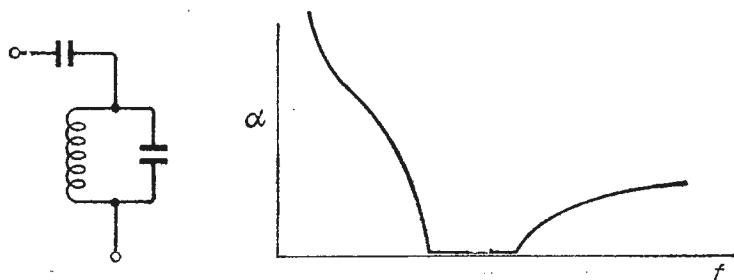
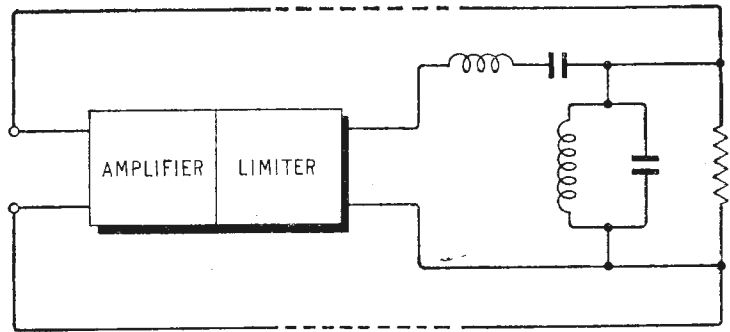
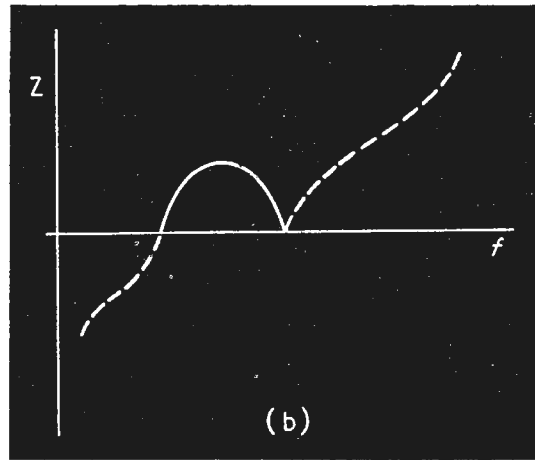

Fig. 8. Attenuation characteristic of 3-element shunt network.



(a)



(b)

Fig. 9. (a) Amplifier-limiter-filter type of oscillator, and (b) image impedance presented to the limiter.

points. The limiter should be symmetrical in action and should have a very short input base.

In this particular technique of amplifier-limiter-network we are faced by a problem in defining what we mean by a limiter. The circuit is loaded not by a resistance but by the input impedance of the network and this will not, in general, be independent of frequency. We therefore have a choice between limiting the output voltage and limiting the output current, between designing the limiter as a low impedance source and designing it as a high impedance source. If we design for a square voltage wave we must accept the fact that the current will be sinusoidal and *vice versa*. We must also choose a network which will accept our choice or will define it.

At this point I reach again for "Radio Engineers' Handbook." The image impedance presented to the limiter in the circuit of Fig. 9 (a) is shown in Fig. 9 (b) and it will be seen that it is high and reactive, for all input harmonics. Consequently although we can hold up a square voltage across the input terminal we shall not pass harmonic current. If we were to use the network the other way round with an amplifier taking a current input we should find that we could get a square-wave current drive and we should have a sinusoidal voltage.

We have a large range of filter networks at our disposal, especially if we allow ourselves to use lattice networks, zig-zag filters and impedance transformations. We can find a very large variety of amplifier and limiter combinations. One such circuit is shown in Fig. 10. You may recognize this as a rearrangement of the basic voltage switching oscillator described by P. J. Baxandall ("Transistor Sine Wave LC Oscillators" *Proc I.E.E.*, Paper No. 2978E, May 1959, Vol. 106B, Supp. 16, p. 748). The amplifier is the well known single-ended push-pull



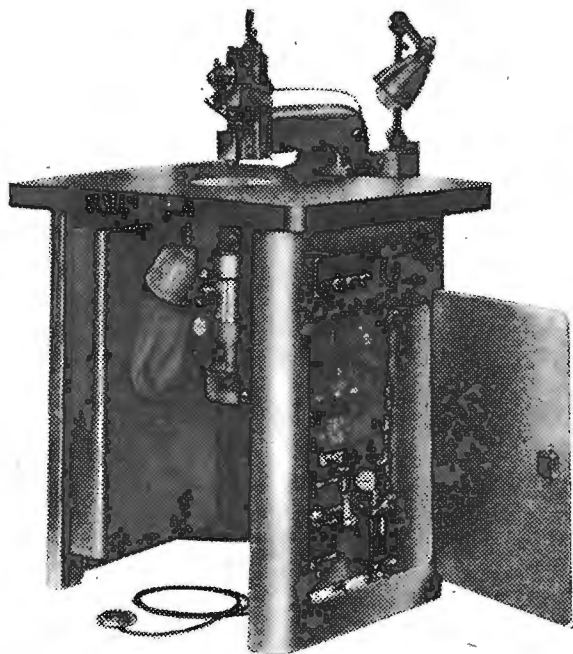

Saunders Dumatic drilling machine.

television analyst (Model 1076) provides r.f., i.f., vertical and horizontal sweep drive and sync pulse outputs. It enables the engineer to investigate receiver faults by using signal injection and substitution methods.

Versions are available for various standards. A test pattern output is produced by a flying-spot scanner and a high level signal is available for direct modulation of the c.r.t. Patterns for colour checks are also generated. The U.K. agents are Livingston Laboratories Ltd., 31 Camden Road, London, N.W.1.

For further information circle 304 on Service Card.

### Drilling Printed Circuit Boards

A SPECIAL machine for drilling circuit boards, either individually or in stacks, is known as the Saunders Dumatic. A template is placed over the work and hole positions are located from above by a pneumatically operated stylus. Pressure is increased when the foot-operated drill rises from below the table and this ensures a burr-free hole when the drill is set to penetrate only half the thickness of the top board, which may be used again as a backing. Swarf is vacuum extracted.

The provisional price is £583 15s and the makers are N. Saunders Metal Products Ltd., 127, Munster Road, London, S.W.6.

For further information circle 305 on Service Card.

### Pocket Signal Tracer

WITH a gain rated at 60dB the "670" pocket test instrument has interchangeable a.f. and r.f. plug-in probes and may be used for tracing signals, hum, noise, etc., in circuits. It is marketed by Controlled Electronics, 62, High Street, Croydon, Surrey, and costs £6 19s 6d including a magnetic earpiece.

For further information circle 306 on Service Card.

### Transmitting Triodes

EITEL-McCULLOUGH have introduced a range of triodes with characteristics suitable for linear amplifier s.s.b. applications. They have been designed to give optimum performance with zero grid bias—so no grid power supply is needed. They give power gains of over 20 and produce intermodulation products less than 35dB below the peak envelope output power. Three glass and three ceramic envelope types are available with ratings varying from 400W to 3kW for the glass types and 1kW to 20kW for the ceramic. These valves

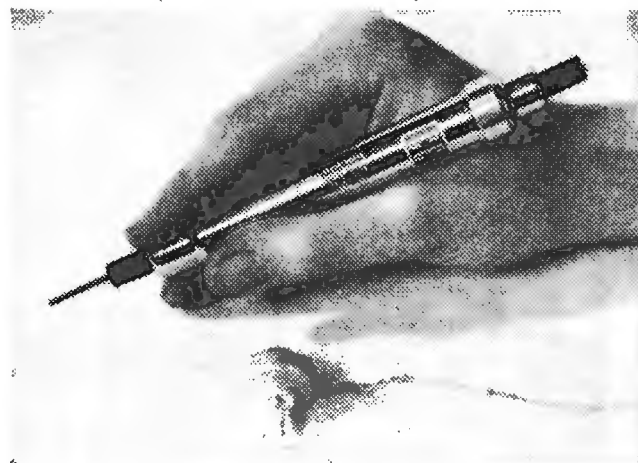

C.E. "670" pocket signal tracer.

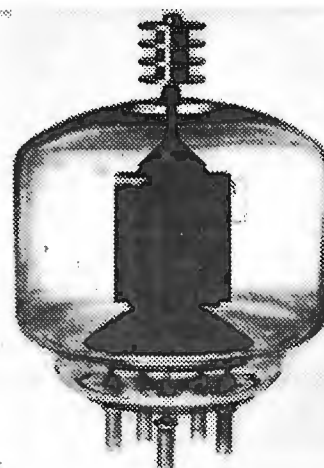

Eitel-McCullough zero bias transmitting triode.

are available in this country from Walmore Electronics Ltd., of 11-15 Betterton Street, Drury Lane, London, W.C.2.

For further information circle 307 on Service Card.

### Solid State Relays

FOR applications where high switching speeds and reliability are essential, M.L. Aviation have introduced a series of solid-state relays. In these units the driving circuit is through a transformer which operates transistor switches. A transistorized oscillator is incorporated in the driving circuit to ensure complete isolation between switch and switching circuit. The relays are fully encapsulated and provided with standard plug-in bases or flying leads as required.

"Contact" rating is given as 1 to 70V d.c. with a maximum current of 1A. The drive current is 600 $\mu$ A at 6V d.c. and a standing supply of 12, 24 or 48V d.c. is also necessary. The operating time is quoted as 1 millisecond. The relays are manufactured by M.L. Aviation Co. Ltd., White Waltham Aerodrome, Maidenhead, Berks.

For further information circle 308 on Service Card.

### Measuring Oscilloscope

A NEW measuring oscilloscope type TF2200 is announced by Marconi Instruments Ltd. Either a.c.- or d.c.-coupled by switch control the instrument has a 12nsec rise time for less than 1% overshoot at 50mV/cm sensitivity and a bandwidth of 35Mc/s where overshoot may be tolerated, as in sine wave examination. With a maximum writing speed of 10nsec/cm sweep delays from less than 1 $\mu$ sec to 5 seconds are

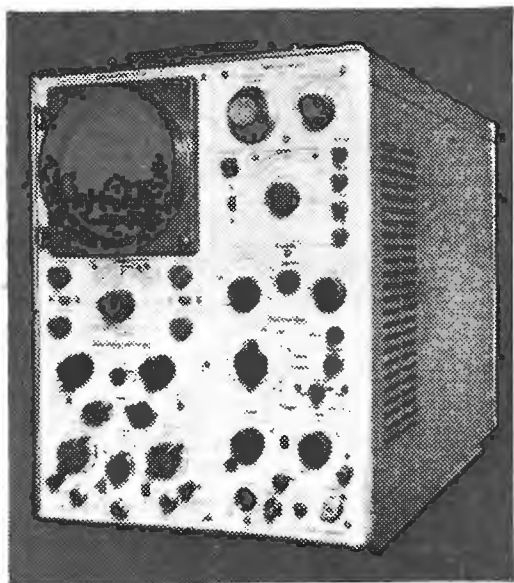

Marconi Instruments oscilloscope, Type TF 2200.

available for detailed waveform examination or line strobe. Triggering controls are simplified.

An interesting feature is the provision of two measuring systems for voltage and time measurement, a calibrated graticule or a calibrated shift potentiometer system. A 5cm display is presented on a tube face of 5in diameter and a post deflection potential of 10kV is used.

Three plug-in pre-amplifiers, single trace, dual trace and differential (for TV) adapt the y input circuit to cover most requirements. All controls are on the front panel and apart from changing pre-amplifiers and probes all modes of operation may be selected by switching without the use of external links. The manufacturers are Marconi Instruments Ltd., Hatfield Road, St. Albans, Herts.

For further information circle 309 on Service Card.

### Transistor Switching Time Tester

USERS of Tektronix sampling oscilloscopes now have available as an accessory the Type 290 Transistor Switching Time Tester. Combined with a fast-rise pulse generator and a sampling oscilloscope, this system provides a transistor testing system with an overall transient response of less than 1 nanosecond. The system tests fast transistors on a short duty-cycle basis for delay time, rise time, storage time and fall time with variable collector voltage and base drive conditions.

The transistor rather than the circuit is tested as far as possible by dispensing with speed-up capacitors or

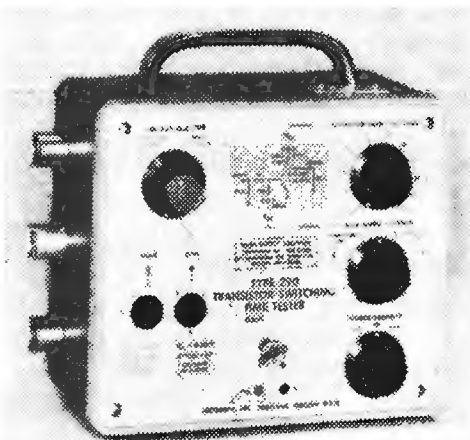

Tektronix Type 290 Transistor Switching Time Tester.

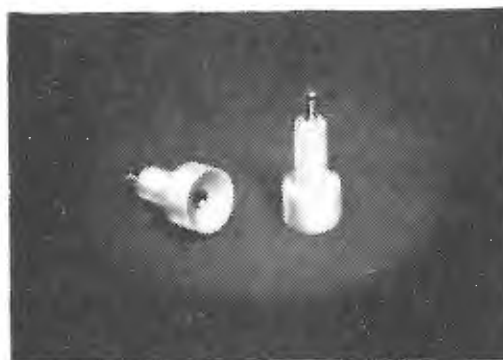

Sealectro SKT-0930 test jack.



Miniature (2-in dia) blower, A. K. Fans Ltd.

catching diodes. The common-emitter base-driven circuit of the instrument introduces into the base of the test transistor a non-overshooting step of current equal to 1mA per volt of input pulse.

Transistor input and output are presented in correct time relationship either simultaneously for dual-trace systems or at the turn of a switch for single-trace systems. The input monitor and output is at a 50-ohm impedance level allowing remote location of tester and sampling system.

The Tektronix agents in the U.K. are Livingston Laboratories Ltd., 31 Camden Road, London, N.W.1.

For further information circle 310 on Service Card.

### Test Jack

THE SKT-0930 test jack is designed to facilitate insertion of test probes in difficult chassis locations and consists of a gold-on-silver-plated beryllium copper socket with a flared Teflon insulator, which is press-fitted into the chassis. The shank is 0.200in diameter and the socket is designed to take an 0.093in dia., 0.5in long probe.

Complete details are available from Sealectro Corporation, Hershams Estate, Walton-on-Thames, Surrey.

For further information circle 311 on Service Card.

### Miniature Blower

A 400-c/s axial flow blower with a 2in diameter moulded impeller an overall length of only 1½in and a weight of 5ozs has been developed by A.K. Fans. Fan performance is 28.5cu ft/min under full flow conditions with a nominal running speed of 11,500 r.p.m. and 12watts input.

This model is claimed to have a life between overhauls of not less than 3,000 hours' continuous operation within the ambient temperature range -65°C to +85°C. The stator windings are fully encapsulated. The fans are made by A.K. Fans Ltd., 20 Upper Park Road, London, N.W.3.

For further information circle 312 on Service Card.

# Nonconductor Valves

POSSIBILITIES IN THE CONTROL OF CURRENTS THROUGH INSULATORS

By "CATHODE RAY"

**R**EMEMBERING that nonconductors or insulators are, by definition, materials through which currents do not flow, you may be wondering what sense to make of the above headings. If so, it will help if memory also recalls that the most complete insulator is a vacuum and yet vacuum valves have made a great deal of sense for nearly everyone for quite a long time.

But, you may say, that's different. Electrons can be shot through a vacuum because there is nothing there to stop them. Insulators, if they are worthy of the name, ought to be able to stop electrons going

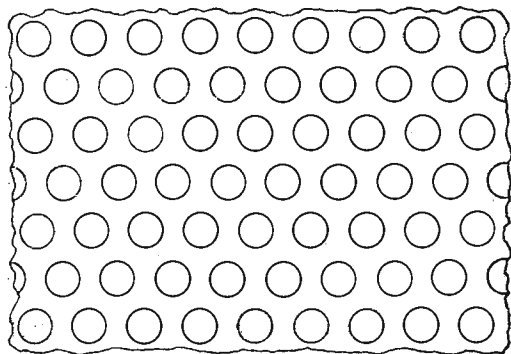

Fig. 1. Elementary diagram of a small piece of perfectly insulating crystal; the circles represent atoms fixed in perfectly regular formation, and with none of their electrons available for conduction. Since each atom is complete it is electrically neutral; its equal positive and negative charges cancel out.

through them. After all, if a valve springs a leak and lets the air in, even that seems to be enough to stop it working. And where are the electrons to come from, anyway? Semiconductors have them—or alternatively holes—distributed throughout the material, ready for use. Nonconductors have none; or, at most, too few to form an appreciable current with any reasonable voltage.

Although there is some truth in these objections, they are not the whole truth. So let us clarify our ideas about electric currents. We started doing this last month, when we saw that there are three kinds of current: displacement, convection and conduction. But we spent most of the time on displacement current—the thing that goes on between the plates of a capacitor and often isn't reckoned as current at all. This month we are concerned with the other two.

The current through a valve or cathode ray tube is an example of the convection kind: a movement of charges introduced from elsewhere, not normally parts of the path itself like the electrons in a conductor. Conduction currents are the "ordinary" sort found in Chapter One of any elementary book on electricity. They are the most complicated and

difficult to understand—a fact about which a discreet silence is maintained in the said elementary book, which works on the principle that education is a process of diminishing deception.

Fortunately we don't have to go fully into the complications to get a rough idea of how to make currents flow freely through insulators. So we shall draw an elementary-book diagram of an enormously enlarged piece of insulator—Fig. 1. Here the circles represent complete atoms, each consisting of a positive nucleus with an electrically equal but negative cloud of electrons around it. As a whole, therefore, it is neutral. The atoms are fixed in position by forces which are prominent among the difficulties referred to above, but the fact that they are fixed means that the insulator is a solid. And they are arrayed in regular formation, which means that it is a crystal. (Another of the things too difficult to explain briefly is that the nature of electrons permits them to flow freely through a perfect crystalline structure provided their "wavelength" is simply related to the regular inter-atom spacing.)

We continue to follow the elementary book in supposing that all the electrons are bound to their respective atoms, whereas in good conductors such as metals at least one electron per atom is free to roam around, as in Fig. 2. And it does, even when no e.m.f. is applied. But such roamings are random, so on the whole cancel out.

When an e.m.f. is applied, the electrons are attracted towards the positive end, and their movement in that direction constitutes an electric conduction current (in the opposite direction, according to convention). But there are the same number of them as before in any part of the metal, which is therefore just as uncharged when current is flowing through it as when there is none. As one can readily

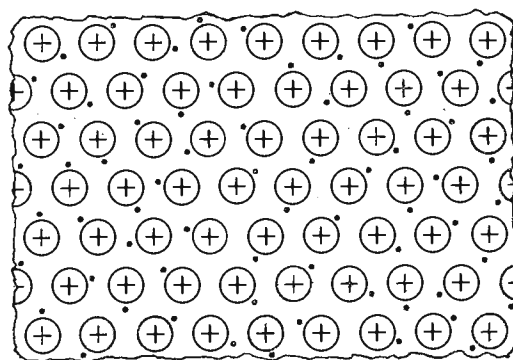

Fig. 2. Here by contrast is a metal, in which each of the atoms has an electron free to take part in a flow of current. Each electron being a negative charge, the fixed parts of the atoms carry an equal positive charge. The material as a whole is neutral.

imagine, the progress of the electrons is considerably impeded by the stationary atoms, like the balls on a pin table. They are interrupted and have to begin again from a standing start so often that instead of accelerating uniformly all the way their average speed is practically constant. This average speed—and therefore the strength of current—is proportional to the e.m.f., as stated in Ohm's law. The obstructiveness of the atoms is usually known as resistance.

In a vacuum, on the other hand, there is no charge at all—or anything else—so when electrons are pushed in and made to flow through it, as in Fig. 3, they charge it negatively. And because charges repel others of the same sign, this space charge (as it is called) discourages those coming on behind from the cathode and restricts the flow. If it were not for the space charge, the current would be limited only by the number of electrons emitted, for (as we saw last month) no e.m.f. is needed to keep a current flowing through empty space. Valve currents are therefore described as "space-charge-limited."

Once the electrons get free from the space-charge huddle around the cathode, they move with constant acceleration to the anode under the influence of the positive voltage there. The ultimate speed they

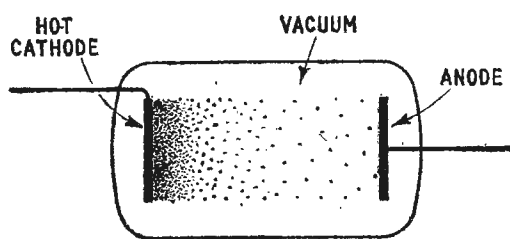

Fig. 3. A vacuum diode, which contrasts with both insulator and metal in having (as nearly as possible) no atoms in the path of the current, so the electrons charge it negatively.

reach is proportional to the square root of that voltage; actually,  $594\sqrt{V}$  km/sec, so even with a moderate V it is considerable. For example, with the very usual h.t. of 250 volts it is 9,400km (or 5,830 miles) per second. This contrasts with one tenth of an inch per second through copper even when the current is very strong.

It is possible—as has been confirmed by experiment—to combine features of both types of conduction by introducing the necessary electrons into an insulator. As these are additional to those already present there, they charge it negatively, as in a vacuum valve (Fig 4). But because the conduction is in a solid crystal, it has something in common with transistor operation.

The obvious question is how to introduce the electrons. Presumably not by clamping a red-hot cathode against the insulator. That might indeed cause current to flow—by ruining the material as an insulator. If, on the other hand, electrons can come out of cold metal, why don't they? It would be most awkward if they did, for all insulators would then conduct.

This is where we have to go into the matter a little farther, to understand why cathode heating is necessary and why electrons don't usually flow from metal into insulators.

So long as an electron is moving around inside the

solid of which it is a part, it is within a virtually uncharged space, as we have seen. But the moment it strays outside it finds itself as a negative charge close to the rest of the solid, which is now an equal positive charge. Their mutual attraction prevents the electron escaping unless its take-off speed is sufficient to carry it clear. This is the same sort of problem as sending a vehicle into space from the earth; the rocket has to give it at least a certain minimum velocity to ensure its departure.

The electron's minimum departure speed is expressed as the voltage needed to give it that speed from a standing start in clear space. The amount of energy it has to possess at the surface to escape is therefore reckoned in electron-volts (eV), and it is called the work function ( $\phi$ ). It varies from about 1 to 7 according to the kind of surface.

Now heat is nothing more nor less than the mechanical energy of the particles of which things are made. Heating a solid makes the loose electrons circulate faster. When their individual energies exceed  $\phi$  electron-volts and they are favourably placed for a take-off, they can escape. To use the familiar technical term, they are emitted. Surfaces such as barium oxide, having a  $\phi$  not much more than 1eV, emit at a dull red heat; those such as bare tungsten (4.5eV) need white heat. Hence the preference for oxide-coated cathodes.

One way of looking at  $\phi$  is as a measure of the attraction between an electron and the solid from which it has been removed. So if two solids having the same kind of surface—and therefore the same  $\phi$ —are brought into contact, electrons can pass equally easily in either direction from one to the other; the attractions of the two cancel out. On the other hand, if surfaces with different  $\phi$ s touch, the one with the greater  $\phi$  tends to collect rather more electrons than the other. This charges it negative, which makes it repel any further electrons. A balance is reached when the potential on that side due to the acquired charge exactly counteracts the difference in  $\phi$ . This difference is called the contact potential, and between different metals is of the order of  $\frac{1}{4}V$ . If you are planning to get a supply of electricity for nothing by joining up lots of these contacts in series, you have to remember that the e.m.f. provided by the contact between metal A and metal B will be cancelled out by the next contact, which must be B to A.

What happens when a metal is brought into contact with an insulator? Insulators have a property called electron affinity, which corresponds to work function in metals, and is usually greater, so that the

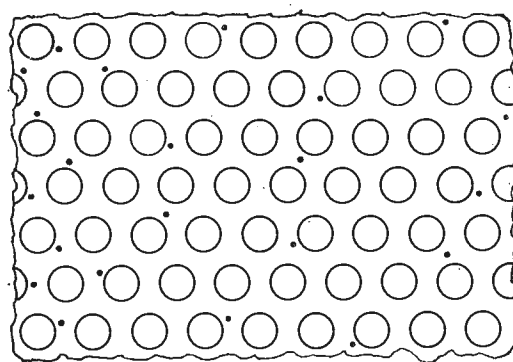

Fig. 4. With the same symbols as in Figs. 1 and 2, a current through an insulating crystal would be represented like this. The atoms being neutral, the current electrons form a space charge.

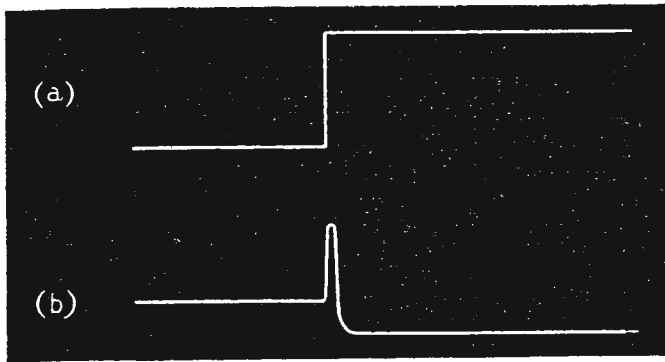

Fig. 5. (a) Potential step between metal and insulator, which prevents electrons flowing freely into the insulator. (b) If the surface of the insulator in contact with the metal has a thin layer of n-type material, the step is reduced to a very thin ridge which is "transparent" to electrons.

insulator becomes negative and repels further electrons from the metal. But it has been found possible to devise contacts that prevent the formation of this potential step or barrier, by diffusing donor impurity—that is to say, one releasing electrons—on the surface of the crystal to a depth of a few millionths of an inch. This cannot eliminate a potential barrier altogether, but instead of a step as in Fig. 5(a) it is a ridge (b) so thin—a small fraction of one millionth of an inch—that electrons can pass through it quite freely by the tunnel effect I described in the August 1960 issue. Such a contact is the equivalent of the hot cathode in a valve, and the crystal takes the place of the vacuum. If a contact at the other side of the crystal is made positive, a space-charge-limited current flows through.

It still isn't quite so simple, because no crystal is perfect, and imperfections act as traps for electrons, delaying them for periods that may extend to days. Every atom is a possible location for such a trap, so even if only one in a thousand is not in perfect crystalline formation the number of traps is enormous. Relatively trap-free crystals have been produced by careful growing and by the process known as compensation—cancelling the effect of residual impurity by adding an impurity of the opposite kind.

These problems have been solved experimentally sufficiently to demonstrate that insulator valves are possible.

But why should anyone want to make them possible? From what I have said they might seem to combine the disadvantages of vacuum and semiconductor valves. The space charge is a nuisance in a vacuum valve, necessitating a high anode voltage to overcome it. And the atoms are a nuisance in solids, obstructing the current flow.

But this would be the wrong way to look at the idea. On the whole, the best features of each are combined. There is the cold cathode, small size and power consumption, almost unlimited life and unbreakableness of the transistor. But unlike the transistor it is not upset by temperature rise. And, as is well known in connection with valves, the space charge reduces noise. Transistors are comparatively noisy devices. High anode voltages are not needed in an insulator valve, because the distance from the cathode can be made very much less than in a vacuum valve. The same feature reduces the transit time between the electrodes, which limits the frequency at which vacuum valves can amplify.

Transistors, in spite of their microscopic inter-

electrode distances, are still more limited, and it is interesting to consider why.

A little while back I contrasted the unimaginably supersonic speeds of the electrons in a vacuum valve with their less than snail pace in the copper wires leading to it, and you may have been left with the impression that this was due to their path through the wire being cluttered with atoms in contrast to the clarity of the vacuum. If so, I must correct it. One could get a given flow of water—say a gallon per second—either by a narrow jet forced out at great speed by high pressure, or by a wide river flowing almost imperceptibly across the plain. Similarly with an electric current. Through the vacuum there are a few electrons flashing by at high speed; in the wires the same current is made up of enormous numbers of them drifting very slowly. Even in a transistor, though free electrons are far sparser than in a metal, they are much more plentiful than in a space-charge-limited device.

Another reason for slow transit in a transistor is that nearly all the collector voltage appears across the base/collector junction, which is a reverse-connected rectifier and therefore presents a very high impedance compared with the main body of base and collector materials. There is, therefore, hardly any electric field across the base region to urge on the electrons or holes received from the emitter. They just diffuse slowly across, like a drop of ink in a glass of water, so no wonder the response to high-frequency signals applied to the base is sluggish. In an insulator valve, however, an appreciable field can be established to expedite the passage of the emitted electrons through the crystal lattice. Moreover, the fewer the active charges, the smaller the input capacitance, and that too helps at v.h.f.

Some basic research has been going on at Birmingham University, an account of which has recently been published by Dr. G. T. Wright (*Journ. I.E.E.*, Oct. 1962) but so far, it seems, the electronic industry has been too busy with semiconductor devices to embark on the considerable development work needed to make insulator valves a commercial success. But it looks as if they offer sufficient attractions to justify the effort. However, don't write to ask me where you can buy some!

#### INFORMATION SERVICE FOR PROFESSIONAL READERS

The reply-paid forms introduced recently to replace the postcards hitherto included have proved to be very helpful to professional readers, judging by the number of forms returned to us. This improved *Wireless World* service is therefore being continued.

The forms are on the last two pages of the issue, inside the back cover, and are designed so that information about advertised products can be readily obtained merely by ringing the appropriate advertisement page numbers. Space is also provided for requesting more particulars about products mentioned editorially.

By the use of these forms professional readers can obtain the additional information they require quickly and easily.



# TRANSISTOR AMPLIFIER OUTPUT STAGES

## 3.—COMMON-EMITTER WORKING CONDITIONS

By O. GREITER

**T**HE two preceding articles have been concerned mainly with the problem of stage structure and have indicated the paramount position of the common-emitter mode of operation. It is therefore essential to ensure that the design principles of this type of stage are clearly understood. A power stage transistor can be regarded as operating under fairly large signal conditions. These are conditions in which the signal is too large for the characteristic to be approximated by its tangent at the working point but in which operation is not extended to reach both the severely non-linear regions although, as in Class B, one of the non-linear regions may be an important fraction of the working range. The object is, in fact, to provide sufficient overall linearity

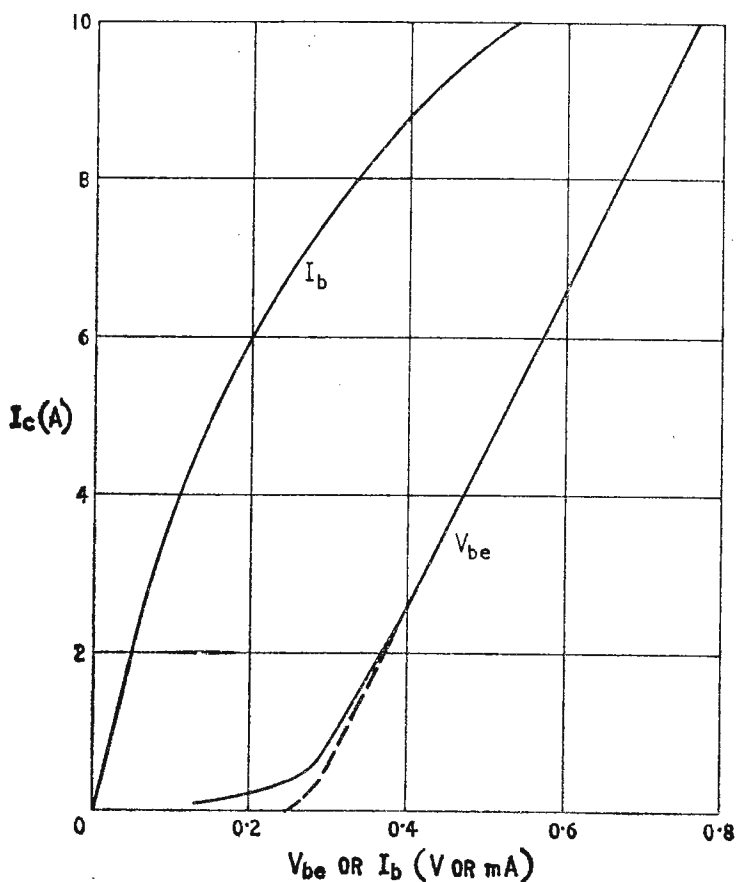

Fig. 10. Typical output transistor characteristics.

for negative feedback to be satisfactory as a distortion-controlling mechanism.

Much of the literature on transistor circuit design is devoted to the problems of common-emitter stages. The first and, in the strictest sense of the word, the most vital is the matter of bias and the stabilization of the operating conditions. In power stages this is a particularly awkward problem since in the analysis of the thermal stability it is inevitable that the heat should be high and that the stabilization should be low. The methods used for stabilizing low-level class A stages are frequently unsuitable for high-level class B stages since they offer a choice between the waste of a substantial part of the power

output and the use of ridiculous values of capacitance.

The biasing of class B stages introduces even more problems, for a new condition is imposed on the bias circuit. Incorrect biasing can lead to crossover distortion and also, in practice, although this is not discussed in the texts, to instability. The instability will only occur when the bias results in extra high gain near the origin due to excessive overlap of the characteristics, and when the amplifier is not designed with adequate stability. Crossover distortion is well-known, but in power transistor stages it is, apparently, not uncommon for crossover distortion to be observed when the amplifier is first switched on and the transistors are cold. This condition is met particularly in car radio circuits when, as is so often the case, the car is kept throughout the winter night under a lamp-post. Since the driver should be driving rather than listening and since few cars have space and few owners the inclination to fit good loudspeaker systems, this particular problem is not of great importance. By the time the driver is warm enough to care the crossover distortion will have vanished. This rather frivolous attitude cannot be applied to serious high-quality equipment and since it is unthinkable that the user should be expected to allow his amplifier to warm up, the designer will need to test with great care to establish that this effect does not occur. It is easily overlooked, since under laboratory conditions some time may elapse after switching on before any measurements are made.

A study of the textbooks reveals some conflict of opinion about the appropriate drive arrangements for common-emitter stages operating at what we are calling fairly high level. We shall consider this from the point of view of distortion generally. It must be stated at once that any conclusions which are reached will be a compromise solution and will, moreover, be a compromise based on inadequate information. Published transistor characteristics seem to fall into two classes. In one class we are given excellent graphs covering an inadequate amount of data, while in the other class we have a large number of graphs so small that even the linear behaviour is difficult to follow. Both sets of information are based on average performance, measured and averaged by engineers like the reader. The curves are drawn, no doubt using some sort of curve-drawing aid, and are redrawn in a drawing office. They do not necessarily cover the whole working range. From these we are attempting to determine the departures from linearity of a real amplifier. It is probably not unfair to accept that the kind of shape, concave up or down, is correct. It would be imprudent to measure the sag and to assign much meaning to it.

The two curves in Fig. 10 indicate the sort of characteristic which is quoted by one manufacturer, brought together so that the features are clearly visible. Particularly distinct is the extremely linear transconductance and on the basis of this we can

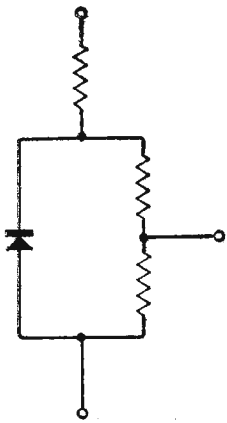

Fig. 11. Bias circuit for low-level stage.

decide without hesitation that this transistor should be operated from a low-impedance source. The shape of the current transfer characteristic makes it abundantly clear that if we allow the input to be a current-controlled signal we shall get a very rounded input-output relationship. The knee of the transconductance graph, however, is surprisingly sharp. If we are to believe the linear portion we must equally believe the knee and when we attempt to fit the two halves of a class B pair together we get a construct shown as a dotted line which indicates a good deal of crossover distortion and a very high sensitivity to the exact bias conditions.

Let us look further at the situation. To obtain a current in the collector of 10 amps we shall need a bias of 0.27 volts plus a signal of 0.5 volts, and the base current will be just over 0.5 amps. The effective input impedance is thus just about 1 ohm. A low-impedance supply feeding a not particularly linear input resistance with an average value at high levels of 1 ohm must have a generator impedance of, say, 0.1 ohm or less. In an analysis of this kind it is sufficient to work in orders of magnitude so that we can watch the broad picture. This sort of source impedance is by no means easy to obtain in a circuit providing a.c. coupling (circuits using d.c. coupling will be treated as compound systems) and when the bias path is added it seems improbable that a solution should be found.

As soon as the bias path is mentioned it directs our attention to the fact that we are calling for a bias of 0.27 volts. If we were considering a low-level stage we might derive this bias from a circuit of the type shown in Fig. 11. The rectifier can be regarded as providing any or all of several functions. To begin with it provides a moderately well stabilized voltage which does not vary too much with changes in the main supply voltage. It has a much lower source impedance than we should obtain for the same current consumption in a purely resistive voltage divider. Some measure of temperature compensa-

tion can be provided against changes in transistor parameters. The value of  $V_{be}$  in a typical power transistor has a temperature coefficient of between  $-2$  and  $-2.5$  mV/deg C. The correct bias for a class B stage is therefore likely to vary over quite a wide range, wider than at first one would think. Newly switched on in an unheated room the junction temperature might be  $10^\circ\text{C}$ , while after running at full load for some time in a warm room  $60^\circ\text{C}$  would be a very conservative figure. This gives a change of value for  $V_{be}$  of at least 0.1 volt. The reader can easily plot for himself the combined characteristic in the crossover region of Fig. 10 when the bias is this much in error.

Since the diode can be kept at heat sink temperature it can be assumed that it will vary in voltage in accordance with the average conditions of transistor operation. There is an averaging effect due to the thermal capacitance of the heat sink and a temperature-dividing effect due to the thermal resistance between the transistor junction and the diode junction. More important at this stage is the fact that a diode operating in its low-impedance region will not provide a bias of the required value and the diode voltage must be divided down in the way shown in Fig. 11. The diode temperature coefficient expressed in mV/deg C is naturally divided down in the same ratio and the approximate compensation is lost.

No account has yet been taken of the effect of temperature on  $I'_{co}$ . The simple concept of a firmly earthed emitter with a partially compensated bias supply is seen to be very dangerous, for it involves the use of resistance in the base circuit. The expressions for determining stability are well known and need not be reproduced here. It is important to note that the minimum stability signal may not coincide with the maximum dissipation signal. This result is derived by Lin (*I.R.E. Transactions on Circuit Theory*, Sept. 1957) but although he shows how for one amplitude of square wave the stability is rather lower than it is for the maximum-dissipation square wave it is not easy to produce a convincing example using an arbitrarily chosen power transistor. In any event square-wave operation will normally be only a test condition and the tester should be prepared for thermal runaway.

Let us leave this matter unresolved at this stage

and let us consider the characteristics of another transistor, shown as Figs. 12 and 13. The notable feature here is the relatively good linearity of the current transfer characteristic in Fig. 13 and the smooth but continued curvature of the input characteristic in Fig. 12. Indeed a test shows that a parabola with its vertex at (200mV, 0mA) can be found to fit this curve to well within normal transistor limits. Here again, therefore, it is perfectly possible to use a low-impedance drive source and we can assume that the current gain is constant enough and

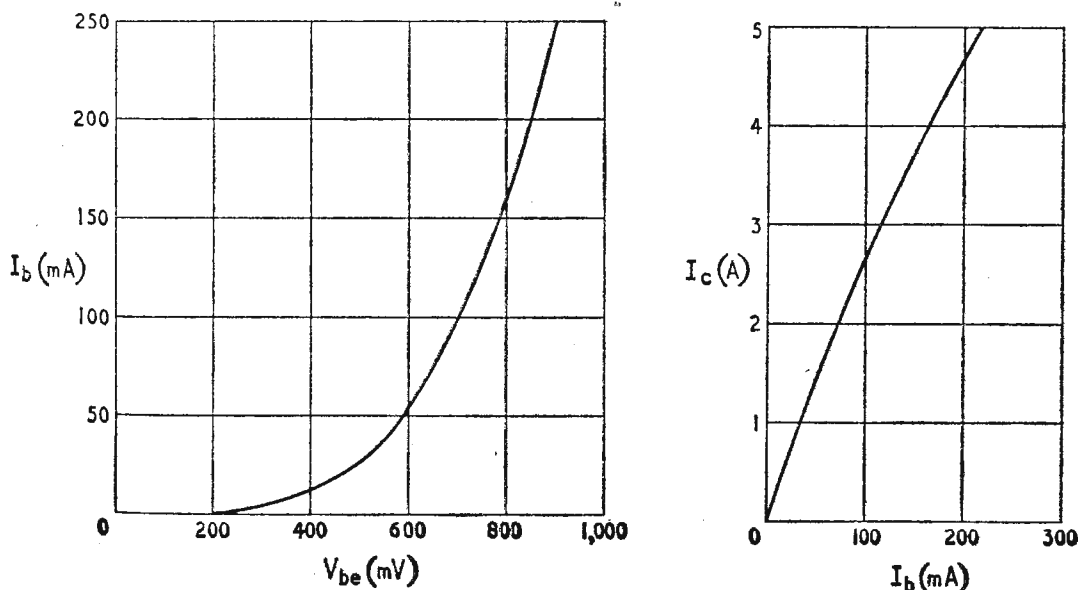

Fig. 12 (left) and Fig. 13 (right). Typical output transistor characteristics.

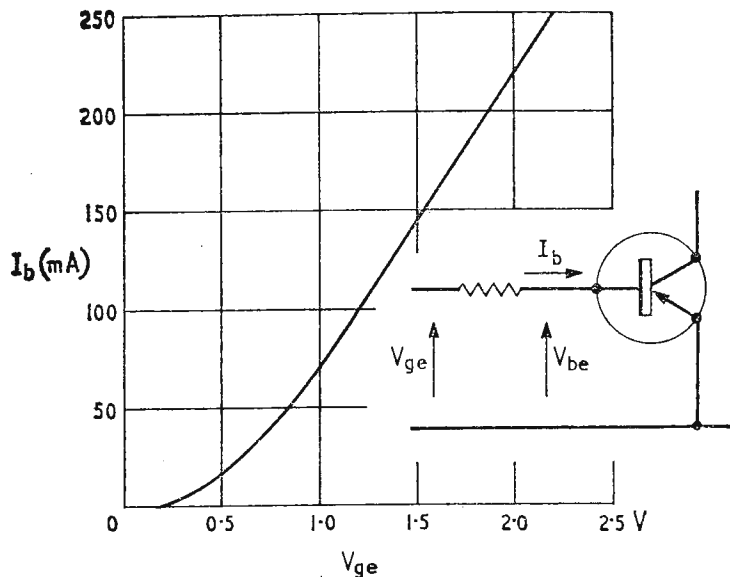

Fig. 14. Effect of a 5-ohm source in straightening the input characteristic.

simply match the two input parabolas one against the other. If we do this on the basis of preserving the match up to a collector current of 5 amps, for which we need a base current of rather over 200mA we find that the bias voltage should be somewhere between 550 and 600mV. The quiescent collector current will then be about 1 amp.

The following reasoning will be found in some of the literature. We wish to straighten out the characteristic of the base-emitter diode and we can do this by **swamping** it with a high resistance. Then we shall need to consider only the current transfer characteristic of Fig. 13. Let us therefore say that a common-emitter stage must be driven by a high-impedance source and all will be well. As an exercise the effect of a 5-ohm source is plotted in Fig. 14. The linearization of the signal voltage (now  $V_{ge}$ )—base current characteristic is very noticeable and although the plot is on a rather small scale it would seem that the bias should now produce a base current of about 15mA, giving a collector current of perhaps 400mA, instead of the base current of 40mA giving over 1 amp.

There is something unsatisfactory about a situation in which the style of a circuit design depends so completely on the shape, in detail, of particular device characteristics. Even if the shapes were covered by some sort of specification, which they are not, we should hardly be able to enforce a claim for specific performance. In addition, as we shall see later, there are other aspects to be taken into account.

In order to compare our procedure with these two conflicting types of transistor we must bring them to the same terms and we can commence by plotting Fig. 15, the  $I_c-V_{be}$  characteristic of our second transistor. Not surprisingly, since the current gain is fairly constant, this has very much the same shape as Fig. 12 but it is undoubtedly very different from the long linear graph of Fig. 10. The obvious step which we can take is to linearize this graph. This can be done quite easily by introducing a resistance and if we assume that the emitter current is the same as the collector current this resistance becomes simply an undecoupled resistance in the emitter lead. A rather rough estimate of the value which will give a result comparable with Fig. 14 is that it must develop about 1 volt across it at a current of 4 amps. The resistance will then be about 0.25 ohms.

A plot of the result is shown in Fig. 16 and it will be seen that it differs very little from the shape shown in Fig. 14 but now, however, there is no residual distortion or intermodulation to be produced by the curvature of the current transfer characteristic. A typical load for the transistor we are considering will be about 5 ohms and so the price of this  $\frac{1}{4}$  ohm in the emitter lead will be small and may, indeed, reveal that we can get more power output by working to a higher current because of the effect of the local negative feedback.

Not only does this reveal an arrangement suitable for a low-impedance drive, but it indicates an arrangement in which the term low-impedance has a different meaning. The same base current must be flowing as before, but now a base current of 200mA needs an input voltage change of about 2 volts, so that the definition of low-impedance introduces the qualification "with respect to 10 ohms." This is a much less exacting requirement than before.

The great advantage which has been gained is the advantage of flexibility. The base can be biased directly from the voltage set by the diode so that we have full compensation for the temperature coefficient of the junction voltage. By choosing a suitable value of emitter resistance we can then set the quiescent current where we will. Automatically we have improved thermal stability of the system, for near the origin we have  $\alpha \approx 32$ , making  $\alpha R_e = 8$  and if we take the base feed resistance as 2.75 ohms we get a factor of stability  $1/1+8/4 = 1/3$ . This is obviously very much better than the value of near unity we obtain if the emitter is connected directly to earth. We can go further and attempt to balance out the effects of the changes in  $I'_{c_0}$  with temperature and there is a certain amount of published material on this question. There is also some evidence of unpublished ingenuity. Short periods of high dissipation will heat the junction well above the mounting plate temperature and any averaged compensation will not come into action. One compensating technique is to use an emitter resistor made of wire with a positive temperature coefficient. If this is a lamp filament or a live wire suspended so that it has a fairly small time constant the compensation will track, rather roughly, the junction temperature. Such a filament may also act as a fuse.

It will be clear that the emitter resistance which is

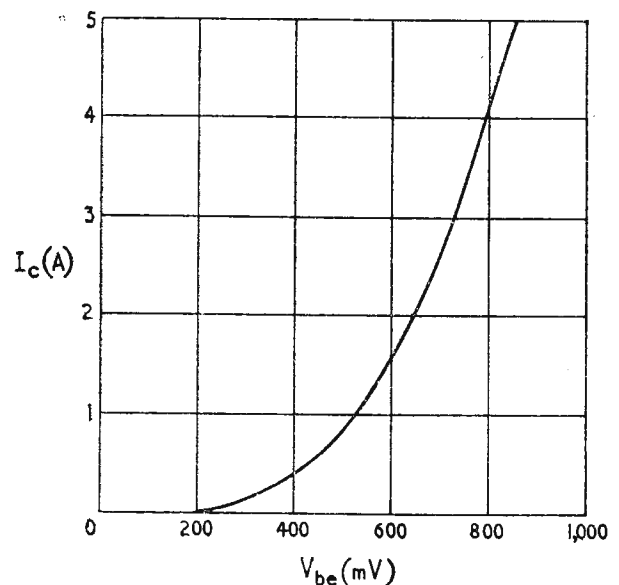

Fig. 15.  $I_c/V_{be}$  characteristic of another type of transistor requiring linearization.

introduced for purely practical reasons, among which we must also include the way in which the matching of a pair of transistors will be improved, will also free the circuit from the restraints on generator impedance which might otherwise be imposed. A high generator impedance will certainly linearize the base-emitter diode but will leave unaffected the curvature of the current transfer coefficient. On the other hand, the emitter resistance, while assisting in the overall linearity, will not be able to affect the fact that the current transfer characteristic is curved, and if a really high impedance base drive is used the feedback voltage will be powerless to affect the situation.

The approach here is rather different from that of Tharma in *Mullard Technical Communications* (Vol. 3, No. 24 May 1957, p. 106 and Vol. 3, No. 29, March 1958). In the first of these references the positive temperature coefficient of the emitter resistance is used to compensate for changes of  $V_{be}$  and he shows that if the temperature coefficient of  $V_{be}$  is 2.5mV/deg C (it is negative in sign) a positive temperature coefficient of 0.004/deg C will compensate the circuit when the drop across the emitter resistance is 0.63 volts. In an example he shows a drop of 0.85 volts giving compensation for  $I_{co}$  as well. The base voltage is held constant. No account is taken of the improved linearity. In the second paper he discusses the combinations of shared or common-bias chains and shared or common-emitter resistances but excludes the form which is of interest when a diode is used for bias stabilization, the shared bias chain with separate emitter resistors.

The use of separate emitter resistors is inevitable in the circuits which make use of transistors in series, as in the output transformerless (OTL) circuits. The merits of the common-emitter resistor as an aid to stability in the traditional push-pull circuit are probably overruled by the flexibility introduced when the resistors are separate. Once the use of temperature-dependent elements is allowed the subject becomes one of very great complexity, for the problem becomes one of balancing distortion, efficiency and power output against maximum operating temperature and heat sink size. Engineers who were taught at school that you cannot equate apples and pears find this type of balance sheet particularly difficult.

We have managed to produce a decision to make use of a low driver impedance on the grounds of circuit convenience, the introduction of an emitter resistance to simplify the biasing and to enable us to bias to a low quiescent current being the dominant factors. A quick check, which is not reproduced as a figure shows that the knee which appears in Fig. 10 is rounded to a more satisfactory shape by the use of this technique although in fact this knee is itself suspect. There is another factor which must also be taken into consideration.

The classical theory of transistor frequency response is usually summarized into the following form. The current gain in the common-base mode,  $\alpha$ , has a frequency variation which can be described approximately by the expression  $\alpha = \alpha_0 / (1 + jf/f_\alpha)$  where  $\alpha_0$  is the low-frequency limit of the current gain and  $f_\alpha$  is the characteristic frequency at which the response has fallen by 3dB. This is an approximation to the theoretically sound expression

$$\alpha = \frac{\alpha_0}{\cosh \frac{\pi}{2} \left( j \frac{f}{f_\alpha} \right)}$$

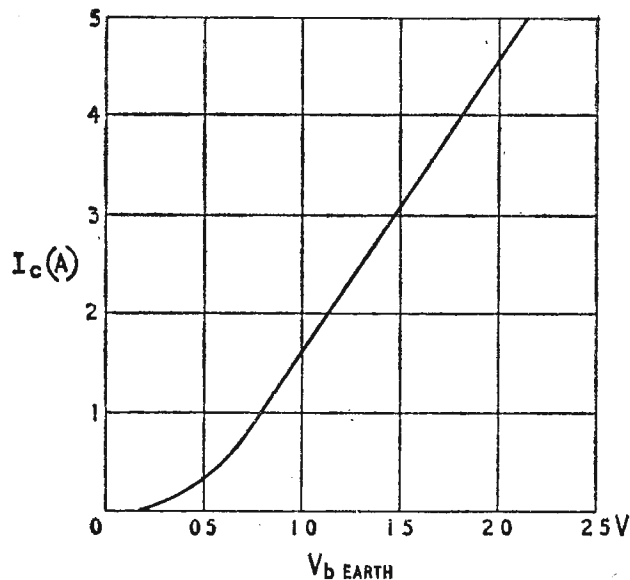

Fig. 16. Transistor of Fig. 15 with added 0.25Ω in the emitter lead.

and it is sometimes important to remember this since the exact expression does not have a limiting phase shift of 90° but at the 20dB down frequency has a phase shift of close to 180°. The significance of this phase shift in the design of feedback amplifiers need not be stressed.

When the common-emitter configuration is considered it is usual to write  $\alpha' = \alpha / (1 - \alpha)$  and to derive from this an expression similar to the one above except that in place of  $f_\alpha$  we have  $f_{\alpha'}$  and

$$f_{\alpha'} = (1 - \alpha_0) f_\alpha$$

The frequency  $f_{\alpha'}$  is often very low, for if  $\alpha_0 = 0.98$  and  $f_\alpha = 250$  kc/s we have  $f_{\alpha'} = 5$  kc/s. In the derivation of this result it has been assumed that the common-emitter transistor is current-controlled but already it has been shown that this is not the condition which will be adopted. An expression which is given for a transistor operated with a resistance  $R_e$  in the emitter lead and a total of  $R_b$  in the base lead is

$$f_{\alpha'_1} = \left[ (1 - \alpha) + \frac{R_e}{R_b + R_e} \right] f_\alpha$$

This can be rearranged into the form

$$\begin{aligned} f_{\alpha'_1} &= (1 - \alpha) \left[ 1 + \frac{1}{(1 - \alpha) + \frac{R_b(1 - \alpha)}{R_e}} \right] f_\alpha \\ &= \left[ 1 + \frac{1}{(1 - \alpha) + \frac{R_b(1 - \alpha)}{R_e}} \right] f_{\alpha'} \end{aligned}$$

The conditions discussed earlier will be such that is a good deal larger than  $(1 - \alpha)$  and a good deal smaller than unity. Two approximations are therefore

$$f_{\alpha'_1} \approx \left[ 1 + \frac{R_e}{R_b(1 - \alpha)} \right] f_{\alpha'} \approx \frac{R_e}{R_b(1 - \alpha)} f_{\alpha'}$$

From this it is possible to draw the conclusion that with a low-impedance drive circuit we are not limited by the common-emitter cut-off frequency. This conclusion merits a much closer examination, which must be postponed until next month.



By "FREE GRID"

## Is Hi-Fi Ni-Fi?

HI-FI is a relative term and merely indicates that the amplifier or what-have-you, to which it is applied, gives a greater degree of fidelity to the original input than do ordinary run-of-the-mill instruments.

The ultimate aim, of course, is to build an amplifier to which the simple term "fi" can be applied. It will obviously never be possible to go beyond that, and so clearly such a term as "super-fi" which I saw recently is absurd. It could only mean that the instrument to which it was applied, went beyond "fi" inasmuch as it added something of its own to the original sound which it was designed to reproduce. If it did that, then it wouldn't be entitled to the honourable title of "fi."

Things are exactly the same if we use the word "reproduction" instead of "fi." Obviously the perfect amplifier and loudspeaker system would be capable of reproduction, and nothing more. Any euphemistic qualifying adjectives would, therefore, mean that the equipment fell short of the goal of reproduction. The term "good reproduction" is permissible in a loose sort of way to indicate that it approaches nearer to the aim of reproduction, than is normally heard.

Now I may be asked what all these obvious statements of mine are in aid of? The answer is that I want to know how near to "fi" is the quality of reproduction which to-day is called "hi-fi"; in other words, is to-day's "high-fi" "nigh-fi"; and if so how "ni" is it to "fi"? Year by year we get closer to "fi"; indeed day by day we get closer to it by infinitesimally small degrees, and I suppose that those skilled in juggling with the calculus are really the only people who could sort it all out.

Personally, I don't think we shall ever reach the goal of "fi," but as the years go on we shall get even closer to it, and the closer we get, the more infinitesimal will be each move nearer to the target. The thing which set me thinking about all this was an article by E. R. Whittaker in our sister journal, *Wireless and Electrical Trader*, some months ago. I don't suppose many of you see this journal as it is intended only for those who—sordid fellows—seek to make a profit out of us by making and selling wireless sets and accessories.

Mr. Whittaker tells us that the "hi-fi" of 10 years ago was by present-day standards, only medium

"fi," we have thus moved considerably nearer to the goal of "fi" in the past decade, and it cannot be doubted, I think, that in 10 years' time our present "hi-fi" standards will sound relatively poor. But I still wonder how "ni" to "fi" is our present "hi-fi"? Can any one of you tell me, or is my question as unanswerable as asking what is beauty?

## TV Aerial Design

I WONDER if any of you, especially those who live in "fringe" or "extra-fringe" areas, noticed—or seemed to notice—a loss of television signal strength during one of the Arctic spells we recently experienced. If so you may have been tempted by your womenfolk into wrong thinking.

The guiding or misguiding rule of every woman in technical matters seems to be "*post hoc, ergo propter hoc.*" Working on this theory Mrs. "Free Grid" misled even me into thinking that because a drop in signal strength occurred when the TV aerial was encrusted with a thick coating of ice, therefore, this was obviously the cause of the trouble.

However, calm reasoning made me realize that she was all wrong. The only cause of signal-strength loss would be a direct electrical leakage between the aerial elements and the earthed support, but ice is an insulator like distilled water, and not a conductor because all the various impurities associated with the water from which it is formed, especially in urban areas, get thrown out when it freezes.

Dismissing this idea of a direct leakage path, I then recalled that the dielectric constant of ice is on the high side. Thus, I reasoned, the ice around the aerial elements could act as a series of paralleled shunting capacitances to the earthed support. The fact that the major drop in signal strength was in the I.T.A. transmission with its higher i.f. seemed at first to support this idea, until I recalled that most TV aerials are rather "broad-band" and will stand quite a bit of mistuning.

The real nigger-in-the-woodpile was, I found eventually, the new I.T.A. aerial at Croydon which had also a new radiation pattern.

Despite all this, however, I do think TV aerial manufacturers should seriously turn their attention to the production of electrically-heated antennae in readiness for the winter of 1964/5 when the 625-line u.h.f. system will be in full swing, and we shall all be using horizontal

aerials. Obviously if these become heavily coated with ice their rods may tend to droop with the weight, more especially some of the very complicated combined-band ones, supported at only one end.

But apart from any question of snow and ice, I would point out that it will be necessary to provide electrical heating for these Band IV aerials at all seasons of the year, because horizontal rods will form natural perching places for various types of bird including the ubiquitous pigeon which is of no mean weight and bulk and so would tend to have quite a considerable distorting effect on the aerial.

Also, of course, the self-capacitance of several well-fed pigeons might just possibly have an adverse effect despite its broad tuning. It is, however, a matter for the slide-rule addicts to work out. Perhaps they will send me a few figures in support or ridicule of my idea.

At any rate it is clear, I hope, that it would be desirable to keep large birds off our Band IV aerials, and hot rods seem to be the answer. The rods need not be so hot as to invite the attention of the R.S.P.C.A.

Of course it might well be that aerial designers already have the matter in hand, and have devised a far better preventive than I have suggested.

## Pioneer Propagation Problems

NOWADAYS continuous radio communication over vast distances throughout the 24 hours of the day is so commonplace that we pay no more heed to it than we do to the constant broadcasting service given by the B.B.C. It is just taken for granted. Things were far different before the first world war, however, as I was recently reminded when re-reading the *Wireless World* Golden Jubilee number of April 1961.

In that issue the author of the history of wireless, writing under the title of "Since the Wireless World Began" stated (p. 161) "a few of the early point-to-point stations, working at distances well beyond daylight range, provided a rather erratic service by taking advantage of night-time propagation conditions."

At the time I first read this, I made a resolve to find out just how many of these direct high-power services were in operation. As far as I can ascertain, there were only two. There was in the first place, the



San Francisco-Honolulu service run by the Federal Co., using the Poulson arc system. As far as I can find out, this service never did succeed in establishing communication in the period when there was daylight over the whole path, but relied solely on night-time propagation.

There was also the link between Port Stanley, in the Falkland Isles, and Montevideo, the Uruguayan capital, the distance being well over one thousand nautical miles. Quite frankly I cannot find evidence of any other long-distance service.

It would almost seem as though the Kaiser did the promoters of the various proposed long-distance services, including our own Imperial Wireless chain, a good turn by saving them the embarrassment (financial as well as emotional) of being unable to fulfil their contracts. The Kaiser's war and its aftermath gave time for the development of beamed short waves which have completely taken the place of the old long waves\* of the pre-1914 efforts at continuous and reliable long-distance communication.

\* The building of v.l.f. stations at Solway and in the U.S.A. is evidence that the lower end of the radio spectrum has not been completely superseded.—ED.

### Etymological Enquiry

I HAVE always been interested to find out when the word "radio" was first used as a synonym for what we in this part of the world call "wireless," and have ventilated my views on the matter previously in these columns.

My only excuse for returning to the subject is that I have had a letter about it from a correspondent. He draws my attention to some remarks by Süsskind in the October 1962 issue of *Proc. I.R.E.* Süsskind states that in 1897 Branly described his coherer as a radio-conductor. Süsskind italicizes the term but my correspondent suggests that Branly, being a Frenchman, would surely have called it a radio-conducteur.

However, my own opinion is that Branly might have used the termination "or" because he thought it had an international flavour. He certainly had a useful precedent a century earlier when, in the interests of international homophony, the French adopted the word kilometre instead of the more correct chilo-metre.

I wonder if any of you can throw any more light on the matter of Branly's term, or name any earlier instances of the use of the word radio as a synonym for wireless.

The orthodox view is that "radio" was coined by the Germans as an acceptable word for use in the first international radio convention drawn up in Berlin in 1903. The word had already been used in a non-wireless sense, in X-ray work and other fields.



## BRAND NEW COMPONENTS

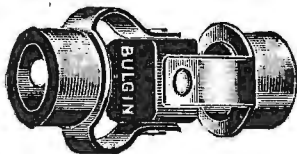

List Nos.: E.H.18, 19, 20.

E.H.18, 19, 20.

A set of three flexible shaft couplers to fit shafts of  $\frac{1}{8}$  in.,  $\frac{3}{16}$  in. and  $\frac{1}{4}$  in. diameter respectively. They will transmit up to 25 in. lbs. torque in up to 10° axial deviation and are therefore suited to many varied applications.

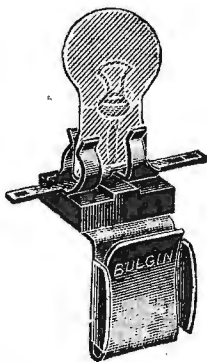

List No. L.C.15.

L.C.15.

We are the first manufacturers in the United Kingdom to develop a lampholder to accept the new "Capless-lamps"; having "open" construction and high insulation its performance, even under adverse climatic conditions, is exceptionally good. There are various fixing brackets or clips available and the range is still being increased. Write now for fuller details and drawings.

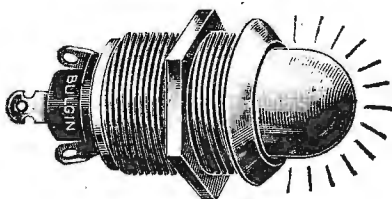

List Nos. D.862-3.

D.862-3.

The Signal Lamp illustrated left incorporates a new design of lamp-holder which has very high insulation properties. It can work at a higher voltage than most signal lamps of comparable size and can also be used under adverse, high humidity conditions.

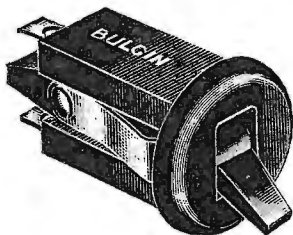

List No. S.805.

S.805.

This completely new toggle switch has been designed to meet heavy duty requirements of up to 10 amps, 250 volts (50c/s A.C. only). The body, operating dolly and front bezel are all moulded, thus giving high insulation and safety even under adverse conditions. Fixing is by push-in, spring grip fit, to a rectangular hole.

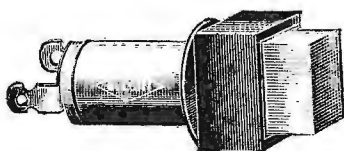

List No. M.P.20.

M.P.20.

A new push-button, for 28 Volt, 3 Amps maximum working, which has an extremely modern and clean front-of-panel appearance. The operating button and bezel are square and are moulded in contrasting colours of red and black respectively. Switching is normally "OFF", press for "ON".

FURTHER DETAILS & DRAWINGS AVAILABLE ON REQUEST

**A. F. BULGIN & CO. LTD.**

BYE-PASS ROAD, BARKING, ESSEX.  
Telephone: RIPpleway 5588 (12 lines)

# MARCH MEETINGS

*Tickets are required for some meetings; readers are advised, therefore, to communicate with the secretary of the society concerned.*

## LONDON

4th. I.E.E.—Discussion on “The evaluation of technologies for fabricating h.f. transistors” at 5.30 at Savoy Place, W.C.2.

6th. British Interplanetary Society.—One-day symposium on “Ground support equipment” at 4 Hamilton Place, W.1.

6th. Brit.I.R.E.—“Travelling-wave crystal amplifiers” by C. S. Brown at 6.0 at the London School of Hygiene, Keppel Street, W.C.1.

7th. Television Society.—“Colour television in medicine” by Prof. R. Warwick at 7.0 at 164 Shaftesbury Avenue, W.C.2.

11th. I.E.E.—“Microwave theory or microwave green fingers?” by L. Lewin at 5.30 at Savoy Place, W.C.2.

13th. I.E.E.—“Pulse techniques in line communications” by R. O. Carter at 5.30 at Savoy Place, W.C.2.

13th. Brit.I.R.E.—“Industrial leadership” by Prof. A. Rodger at 6.0 at the London School of Hygiene, Keppel Street, W.C.1.

14th. Radar & Electronics Assoc.—“The rôle of the computer in radar systems” by D. Hunter at 7.0 at the R.S.A., John Adam Street, W.C.2.

15th. Institute of Navigation.—“The application of inertia navigation systems to air transport” contributions from several authors at 2.30 at 10 Upper Belgrave Street, S.W.1.

18th. I.E.E.—Discussion on “Merits of using the metric system” at 6.0 at Savoy Place, W.C.2.

19th. I.E.E. and R.Ae.S.—Discussion on “Semiconductors and their application to airborne equipment” at 6.0 at Savoy Place, W.C.2.

20th. Brit.I.R.E.—Symposium on “Multi-aperture ferrite devices” at 6.0 at London School of Hygiene, Keppel Street, W.C.1.

25th-27th. I.E.E.—Convention on h.f. communication at Savoy Place, W.C.2.

27th. Brit.I.R.E. and I.E.E.—Discussion on “Instrumentation for applied psychology” at 6.0 at the London School of Hygiene, Keppel Street, W.C.1.

## ARBORFIELD

14th. I.E.E.—“The general problems of f.m. multi-channel communications” by R. G. Medhurst at 5.0 at the Garrison Hall, Arborfield Camp.

## BASINGSTOKE

1st. Brit.I.R.E.—“Self-adaptive control systems” by K. R. McLachlan at 7.30 at the Technical College.

## BEDFORD

18th. I.E.E.—“Solid circuits” by J. Walker at 7.0 at the Bridge Hotel.

## BIRMINGHAM

4th. I.E.E.—“What is a magnetic field?” by J. J. Matthews at 6.30 at the James Watt Memorial Institute.

25th. I.E.E.—“Some aspects of radio propagation research” by Dr. K. G. Budden at 6.0 at the James Watt Memorial Institute.

28th. I.E.E. & Brit.I.R.E.—Symposium on “Automatic control” at 10.15 at the Electrical Eng'g Dept., the University.

## BRISTOL

12th. Television Society.—“U.H.F.” by H. W. N. Long at 7.30 at Royal Hotel, College Green.

27th. Brit.I.R.E. & British Computer Society.—“Hybrid computers” at 7.0 at the University Engineering Lecture Rooms, Queens Building, University Walk.

## CAMBRIDGE

20th. I.E.E.—“Electronics in neurophysiology” by P. E. K. Donaldson and Dr. J. G. Robson at 8.0 at the Dept. of Physiology, Downing Street.

## CARDIFF

6th. Brit.I.R.E.—“Masers and lasers” by Dr. R. C. Smith at 6.30 at the Welsh College of Advanced Technology.

27th. Society of Instrument Technology.—“Electronic weighing” by L. F. Cohen at 6.45 at the Welsh College of Advanced Technology.

## COVENTRY

25th. Brit.I.R.E.—“Satellite communications” by R. W. White at 7.15 at the Herbert Theatre.

## CRAWLEY

27th. I.E.E.—“Some aspects of the use of computers in process-control applications” by J. F. Roth at 6.30 at the Institute of Further Education.

## EDINBURGH

12th. I.E.E.—“Some aspects of the use of computers in process-control applications” by J. F. Roth at 7.0 at the Carlton Hotel, North Bridge.

13th. Brit.I.R.E.—“Communication satellites” by L. F. Mathews at 7.0 at the Department of Natural Philosophy, The University, Drummond Street.

19th. I.E.E.—“The Fylingdales ballistic missile early warning station” by F. Harrison at 7.0 at the Carlton Hotel.

28th. I.E.E.—Faraday lecture on “Electronics—the key to air safety” by Dr. E. Eastwood at 7.0 at the Usher Hall.

## EVESHAM

1st. Brit.I.R.E.—“Electrical synthesis of music” by A. Douglas at 7.0 at the B.B.C. Club, High Street.

11th. I.E.E.—“Transistor video amplifiers for colour television” by F. G. Parker at 7.30 at the B.B.C. Club.

## FARNBOROUGH

19th. I.E.E.—“The principles and operation of large radio-telescopes” by Dr. A. Hewish at 6.15 at the Technical College.

26th. I.E.E.—“Communication tests using the Telstar satellite” by Capt. C. F. Booth at 6.30 at the Technical College.

## GLASGOW

11th. I.E.E.—“Some aspects of the use of computers in process-control applications” by J. F. Roth at 6.0 at

the Royal College of Science and Technology.

14th. Brit.I.R.E.—“Communication satellites” by L. F. Mathews at 7.0 at 39 Elmbank Crescent.

## IPSWICH

4th. I.E.E.—“The automatic control of machines for assembling mechanical components” by A. V. Hemingway at 6.30 at the Electric House.

## LEICESTER

19th. Television Society.—“GRACE” by C. G. Lloyd and J. G. Allen at 7.30 at the New Vaughan College, St. Nicholas Street.

## LIVERPOOL

4th. I.E.E.—“Optical masers” by I. L. Davies at 6.30 at the Royal Institution.

## MALVERN

28th. Brit.I.R.E.—“Techniques for precise frequency measurement in the microwave region” by K. G. Hope at 7.0 at the Winter Gardens.

## MANCHESTER

7th. Brit.I.R.E. and I.E.E.—“Satellite communications” by W. J. Bray at 7.0 at the Reynolds Hall, Manchester College of Science and Technology.

13th. I.E.E.—“The Atlas computer” by Dr. D. B. G. Edwards at 6.15 at the Electrical Eng'g Dept., the University.

19th. I.E.E.—“Some aspects of the use of computers in process-control applications” by J. F. Roth at 6.15 at the Engineers' Club.

## NEWCASTLE-ON-TYNE

4th. I.E.E.—“The impact of the epitaxial technique on semiconductor devices” by Dr. J. T. Kendall at 6.30 at Rutherford College of Technology, Ellison Place.

13th. Brit.I.R.E.—“Manufacture and test procedure of reliable resistors” by B. H. Nichols at 6.30 at Nevillie Hall, Westgate Road.

18th. I.E.E.—“The principles and operation of large radio-telescopes” by Dr. A. Hewish at 6.30 at Rutherford College of Technology, Ellison Place.

25th. I.E.E.—Faraday Lecture on “Electronics—the key to air safety” by Dr. E. Eastwood at 7.15 at City Hall.

## PORTSMOUTH

20th. I.E.E.—“Delta—modulation” by R. T. A. Standford and A. Poulett at 6.30 at the College of Technology.

## RUGBY

13th. I.E.E.—“Superconductivity” by Prof. W. F. Vinen at 6.30 at the College of Engineering Technology.

## SOUTHAMPTON

12th. I.E.E.—“Pulse transformers” by Dr. R. C. V. Macario at 6.30 at the University.

26th. Brit.I.R.E.—“The analogue computer as a tool in engineering research and design” by A. J. Collins at 7.0 at the Lanchester Building, the University.

## WOLVERHAMPTON

6th. Brit.I.R.E.—“Lasers and their practical applications” by K. D. Harris at 7.15 at the College of Technology.